

SAFETY RULES Catarzi **FOR AMUSEMENT RIDE** "Kangaroo" Kiddie

1. Be sure you understand the use and function of controls, signal systems and safety devices.
2. Be familiar with the ride manufacturers manual.
3. Inspect and test the entire ride before each operating period.
4. Stop the ride when any unusual noise or condition develops. Do not operate the ride until your supervisor has inspected and repaired the ride.
5. Remain in control of the ride at all times. Never allow unauthorized persons to operate the ride.
6. Do not operate the ride at unsafe speeds or load it beyond its rated capacity.
7. Be alert when the ride is operating for an emergency stop.
8. Be aware of changing weather conditions. Do not operate the ride during high winds or electrical storms.
9. Persons that appear to be ill or under the influence of alcohol or drugs should not be allowed on the ride.
10. Be sure the riders fit the ride. Children should meet minimum size requirements. Adults must fit safely and comfortably into the seat.
11. Safety belts, lap chains or safety bars must be properly secured before starting the ride.
12. Patrons waiting for the next ride must be kept outside of fence or away from the moving ride.
13. Ensure patrons remain seated until the ride comes to a complete stop.
14. Know the location of the closest First Aid Station and fire extinguisher
15. Any incident, no matter how small, must be reported to the office at once.

Take Pride in Operating Safely

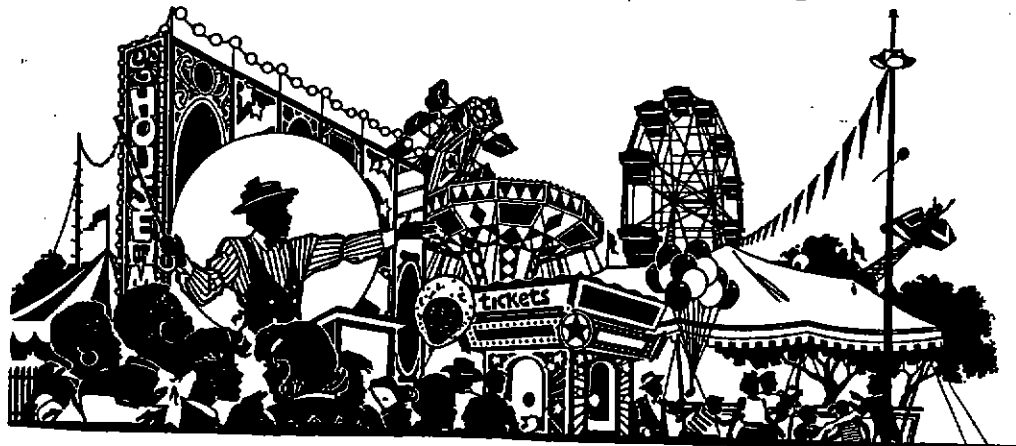

CATARZI AND CO. INC.
DESIGNERS AND BUILDERS OF AMUSEMENT RIDES
8615 HUNDY AVE.
GIBSONTON, FL 33534
PHONE (813) 677-6620
FAX (813) 672-0163

DIANE JOHNSON
EXCLUSIVE SALES FOR CATARZI AND CO. INC.
1015 EAST BRANDON BLVD.
BRANDON, FL 33511
WINTER PHONE (813) 685-2569
SUMMER PHONE (910) 579-2011

CATARZI AND CO. INC., DESIGNERS AND BUILDERS OF AMUSEMENT RIDES

TOTAL _____
RIDE DURATION 3 min. max.
LOADING RECOMMENDED BALANCE
MECHANICAL H.P. 5 Hp.
ELECTRICAL POWER 220 SINGLE PHASE
MINIMUM HEIGHT 36" INCH
MAXIMUM HEIGHT 60" INCH

CATARZI AND CO. INC., DESIGNERS AND BUILDERS OF AMUSEMENT RIDES

SERIAL # FLT-6333 55 YEAR 1997
CAPACITY 16 R.P.M. 6
DIRECTION OF TRAVEL COUNTER CLOCK WISE
PASSENGER CAPACITY BY WT. 250 PER CAR 250
TOTAL _____
RIDE DURATION 3 min. max.
LOADING RECOMMENDED BALANCE
MECHANICAL H.P. 5 Hp.
ELECTRICAL POWER 220 SINGLE PHASE
MINIMUM HEIGHT 36" INCH
MAXIMUM HEIGHT 60" INCH

CATARZI AND CO. INC., DESIGNERS AND BUILDERS OF AMUSEMENT RIDES

Tommy the Kangaroo

Trailer Specifications

1. All Electric Brake
2. Tandem Axle
3. Ball Hitch 2 5/16" / Pindle Hook / Fifth Wheel Hook-Up
4. 24' Length, 12'6" High, 8' Wide
5. All D.O.T. Lighting
6. Leveling cranker on 4 corners
7. Designed to pull doubles

Tommy the Kangaroo

Specifications

1. Theme Painted Figures
2. Theme Painted Front
3. All Aluminum Fencing
4. All Aluminum Platforms
5. All Electric/National Code Wiring
6. Trailer to D.O.T. Specifications

Serial # FLT-6333 JJ Year 1997

Capacity 16 R.P.M. 6

Tommy the Kangaroo

Electric Supply

1. 220 Single Phase
2. 30 amp Main/W/Brand Circuit Breakers
3. 100' Type So Lead Wire
4. Invertal Type Control
5. Auto Timer
6. National Code Wiring

Set Up Time

1. 2 Men Approximately 1 Hour

Tommy the Kangaroo

Set Up Procedure

Space Required 35' Dim. 14' High

1. Level Trailer using Proper Blocking.
2. Level Floor Runners using Proper Blocking.
3. Lower Platform.
4. Lower Track and Pin Down.
5. Set Tubs to Outside of Platform and Remove Racking.
6. Install Sweeps. Make Secure Key Pins and use a Light Grease on Pins.
7. When Installing the Last Sweep, Raise up Height to Install the Last Pin.
8. Install Tubs on Sweep. Make sure to Tighten Main Bolt using a Lock Washer.
9. Install All Fence/Ramps/Light Poles/Gates.
10. Install Bally Cloths.
11. Hook up Electric. Make sure that All Switches are Off.
12. Re-Check all of the Ride.
13. Make sure that All Racking is Clear.
14. Turn Ride On and Check.

Tommy the Kangaroo

Daily Check List of Ride

1. Check All Pins/Nuts/Bolts and Safety Keys
2. Check All Safety Straps.
3. Check All Safety Signs are in order.
4. Check All Blocking.
5. Check All Track Tie Downs.
6. Check All Electric Controls.
7. Turn Ride on and Run.
8. Check Speed.
9. Check that All Moving Parts are Working Smoothly.
10. Check All Wheels for Wear and that All Bolts & Nuts are Tight.
11. Check All Lighting.

Tommy the Kangaroo

Operations

1. No Smoking
No Carry on Items
No Bare Feet or Flip Flops
No Food or Drink
2. Handicapped Children under Special Consideration
3. No Adults
4. All Warning Signs visible to Patrons

3

page I Willie the whale on Tommy Kangaroo

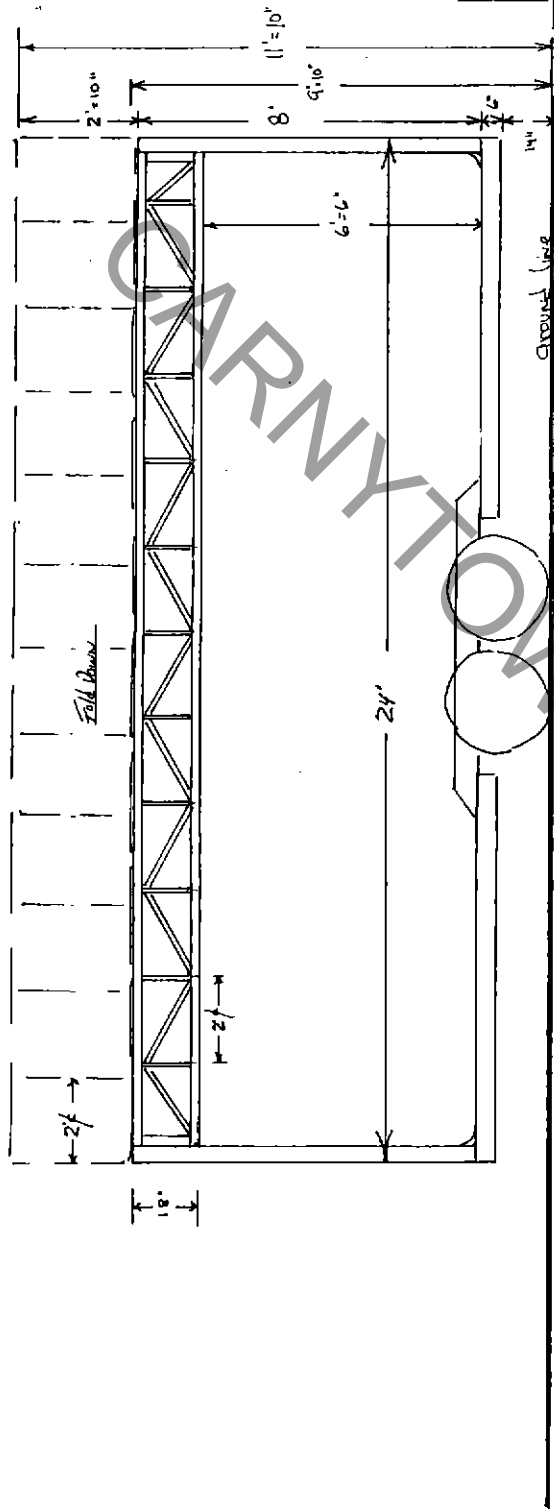

SIDE VIEW

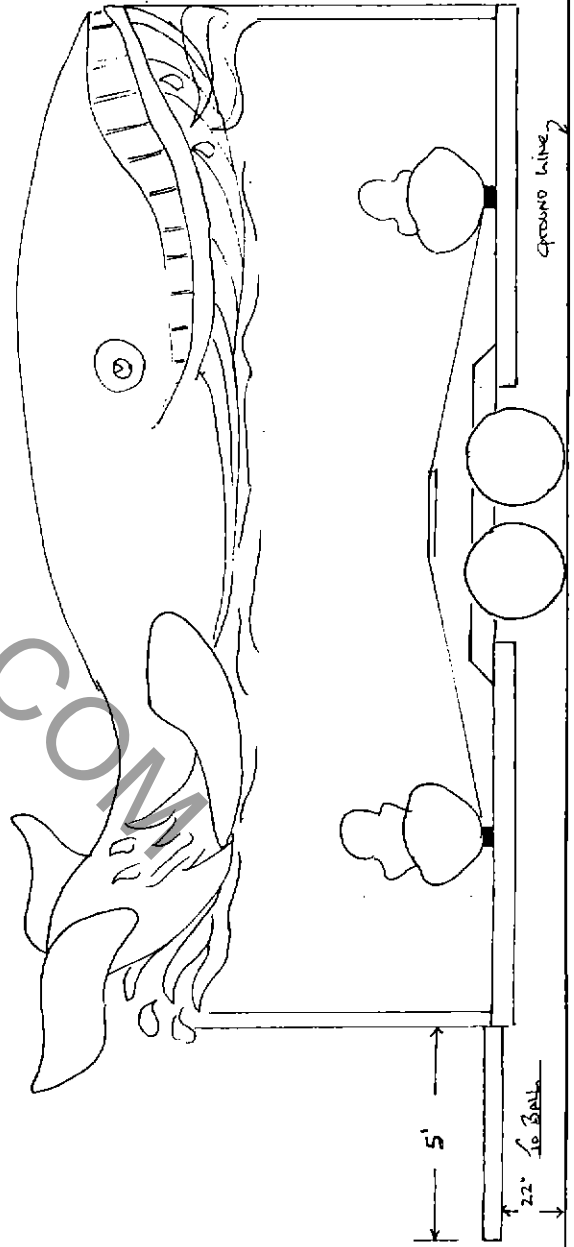

Side View

FRONT & BACK VIEW

- MATERIAL LIST
- ① = 2" x 4" x 24' x 1 1/2"
 - ② = 2" x 4" x 20' x 1 1/2"
 - ③ = 1" x 2" x 24' x 1 1/2"
 - ④ = 1" x 1" x 24' x 1 1/2"
 - ⑤ = 2" x 3" x 3/4" ANGLE 30
 - ⑥ = 1/4" x 1" PLAT
 - ⑦ = 1/4" x 2 1/2" PLAT
 - ⑧ = 1/4" x 3" PLAT
 - ⑨ = 1/4" x 1 1/2" x 14 1/2" x 2 1/2"
 - ⑩ = 1/4" x 1 1/2" x 20" PLAT

Author: Tommy Kangaroo
 Date: 3/19/50
 For: Willie the whale, Carco Im.
 For: S. CORANZ, CATCO INC.
 K.O. # 2-T

Trailer Frame layout CARCO. 4.95

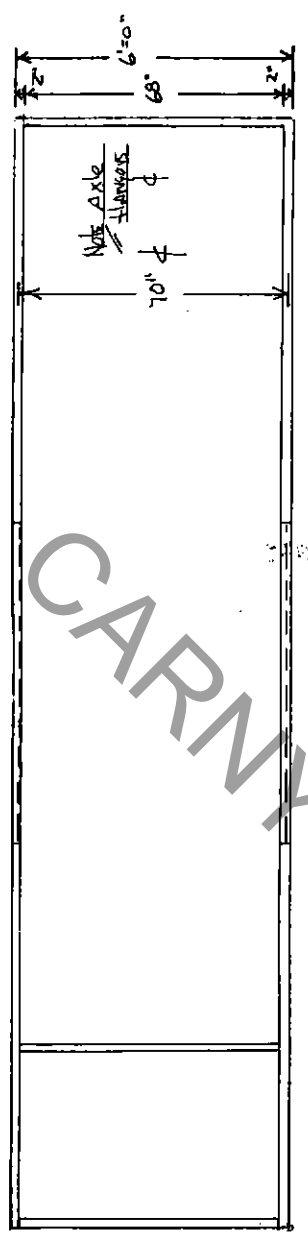

Main Trailer Frame is 2" x 6" x 1/4" wall
Rechtlinger tubing

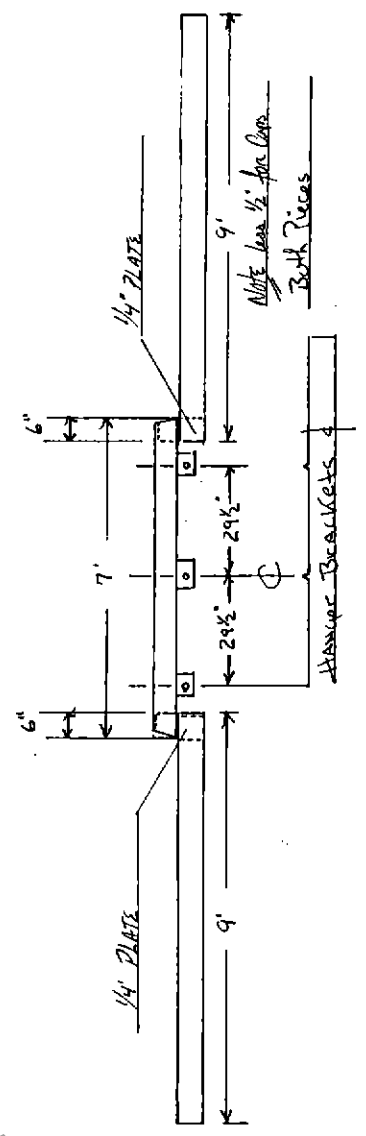
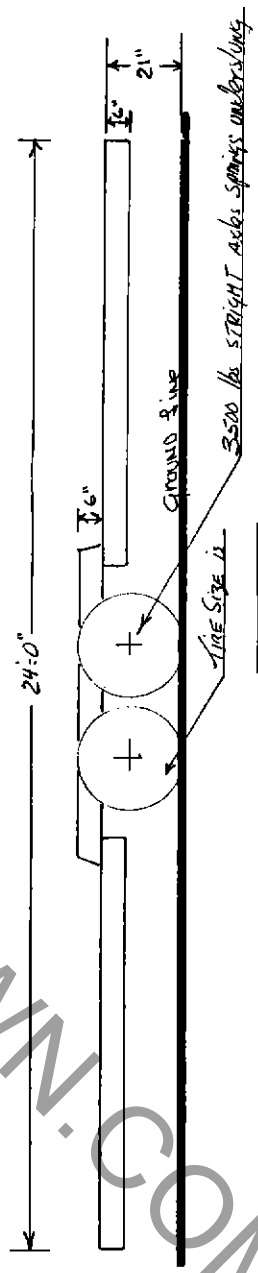

3

CARNY TOWN.COM

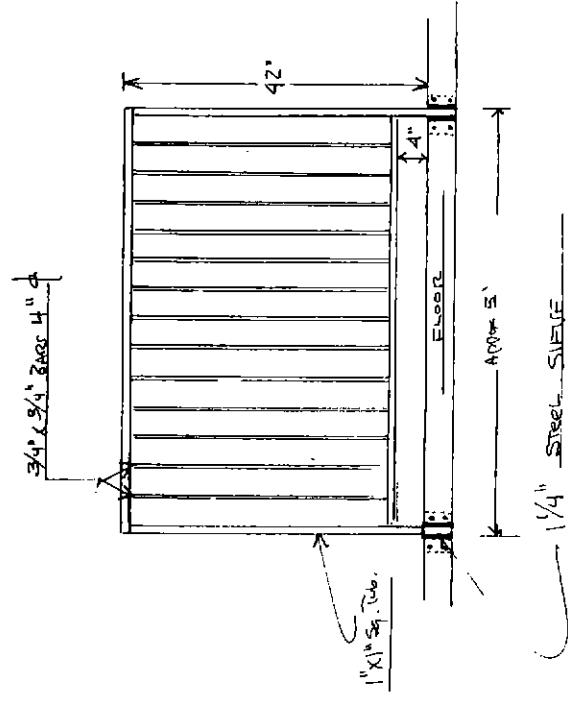
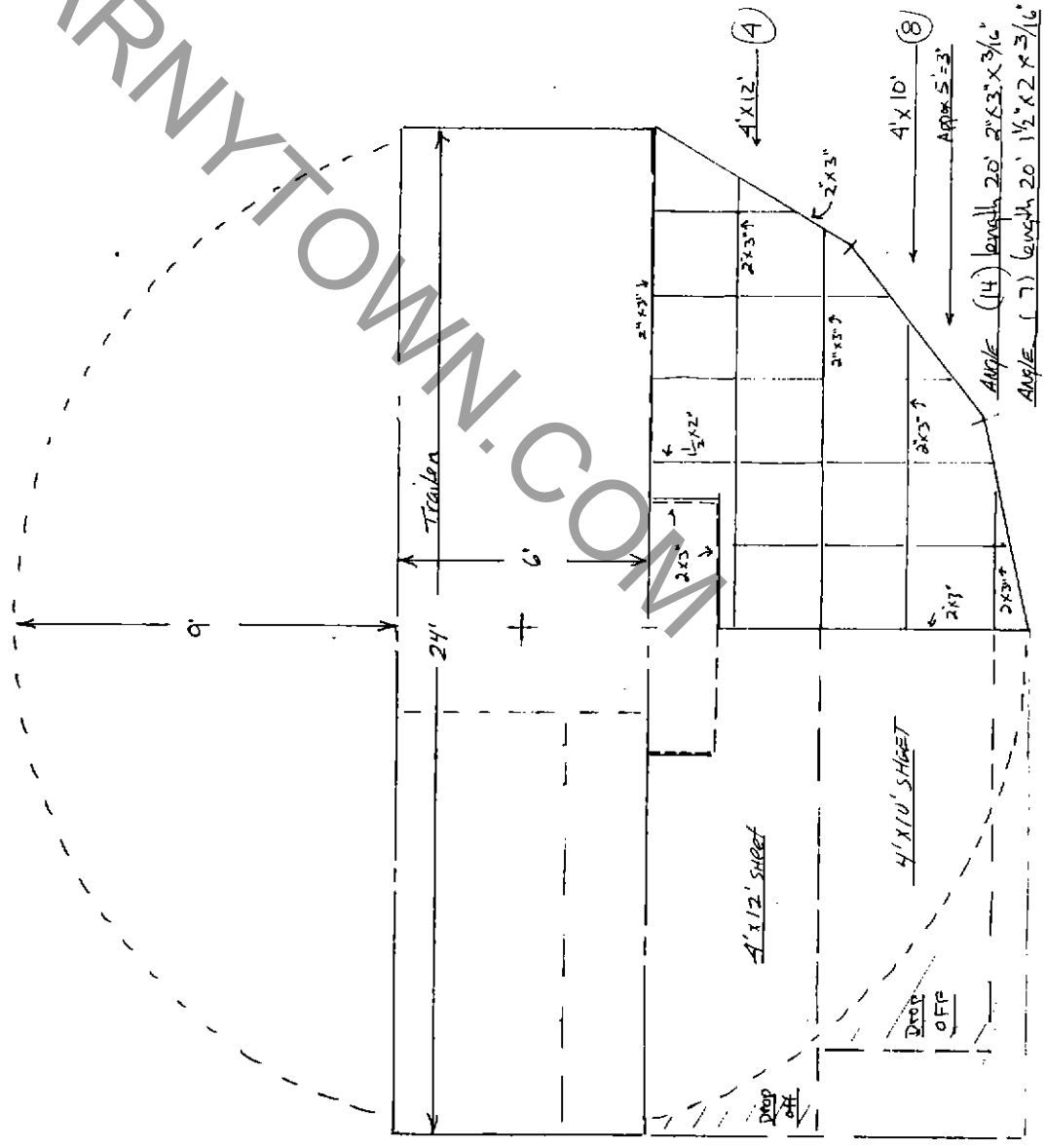

- Rebaring
- (16) 2# 6x4 1/2" dia
 - (4) 3/4" x 24" dia
 - (1) 1/4" x 2" dia
 - (1) 1/4" x 1" dia

Widely Ribbed Plat Forms Training
 PART NO. 200 55
 1955
 J. CATARZI
 Whole & Motor-Cycle CATCO. INC.
 FOR: J. CATARZI - CAT CO. INC. NYR-3-P

BLOCKING ON GROUND SLOPE

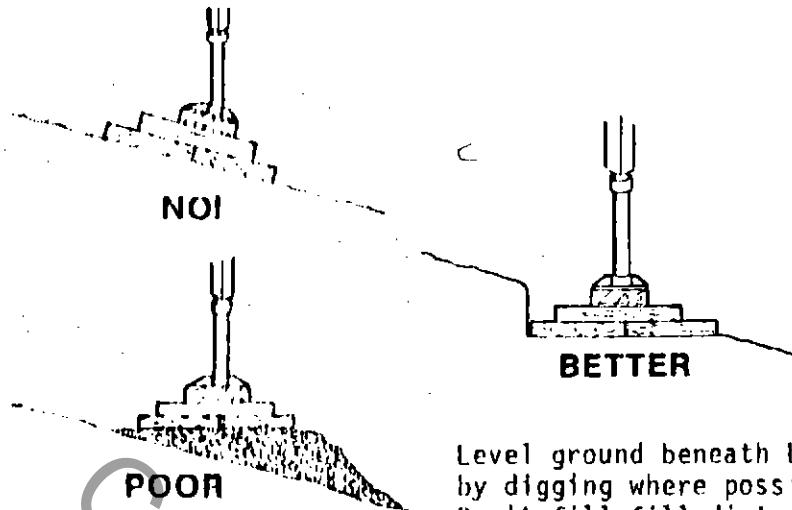

Level ground beneath blocking by digging where possible. Don't fill-fill dirt will be soft and allow ride to tilt.

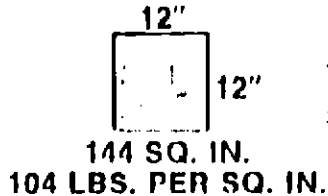
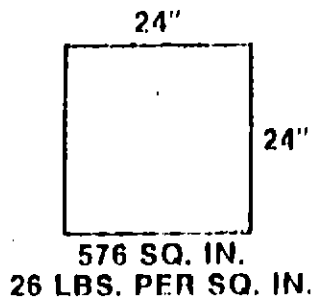
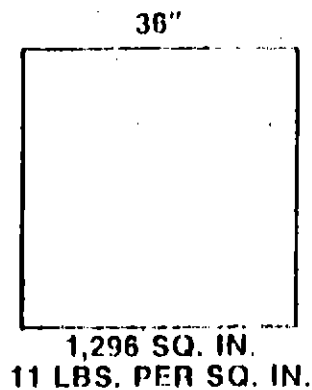

**AVERAGE
RIDE
WEIGHT**

60,000 LBS.

**4 JACKS
15,000 LBS.
EACH**

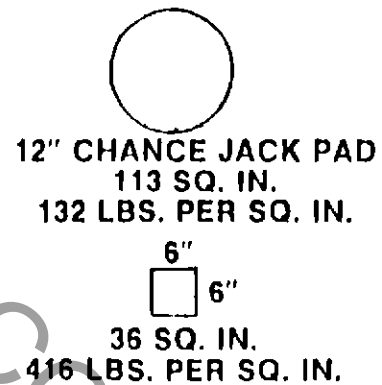

"CRIB" BLOCKING

WRONG

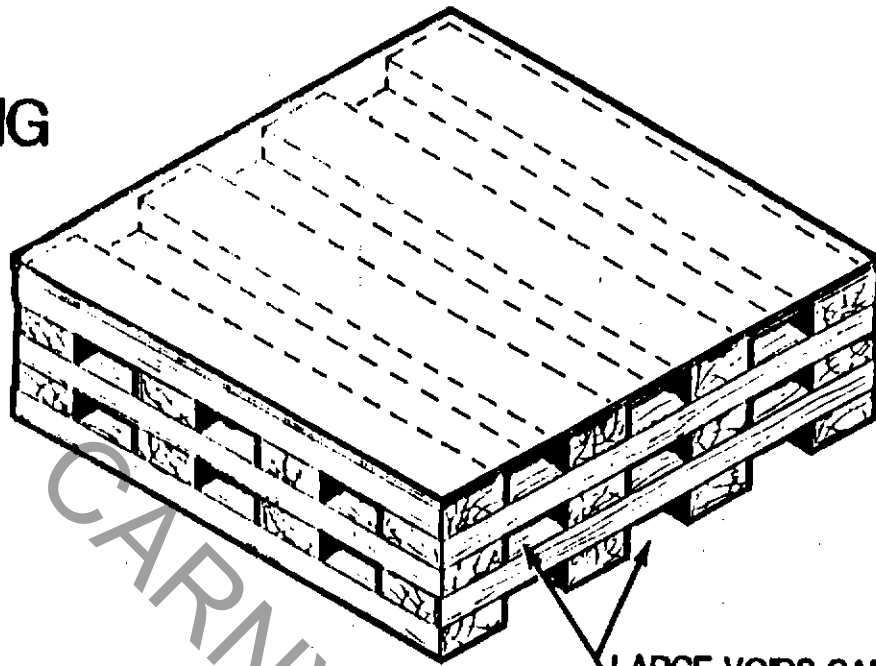

LARGE VOIDS CAN LET
BLOCKING CRUSH UNDER LOAD

BETTER

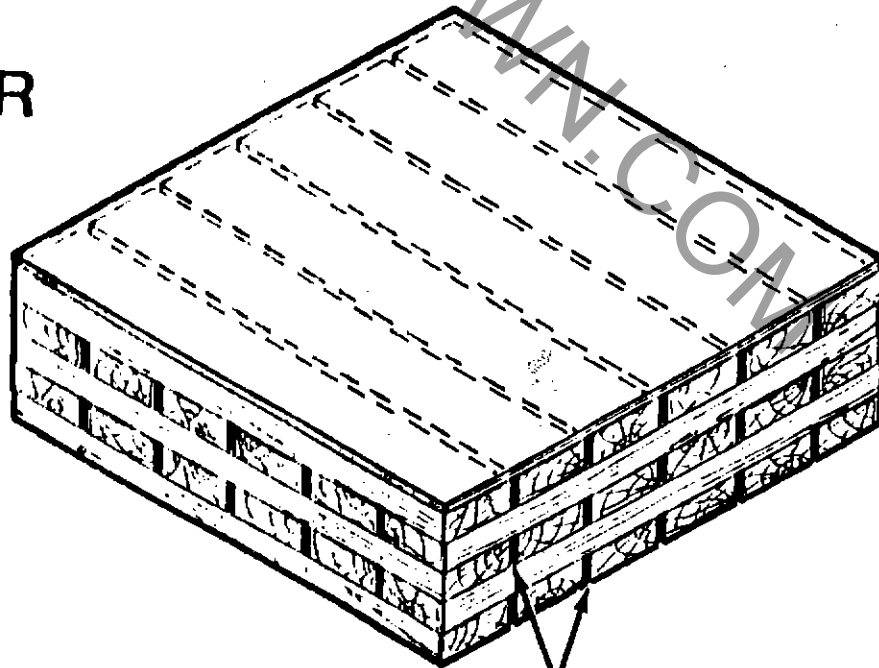

1/4" SPACES FOR DRAINAGE

ALWAYS CROSS BLOCK

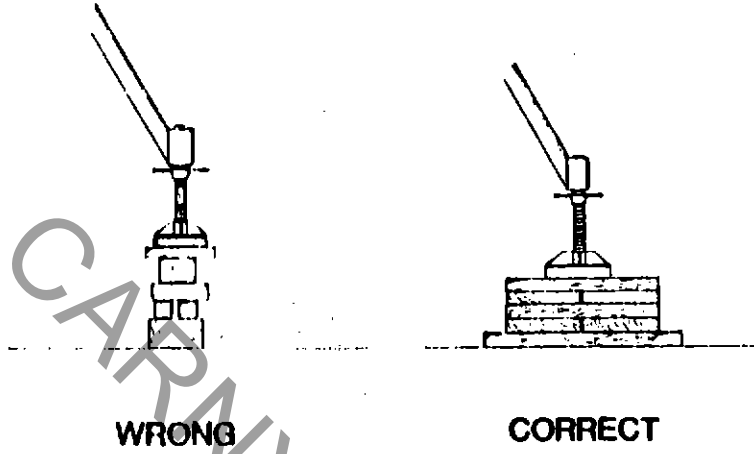

WRONG

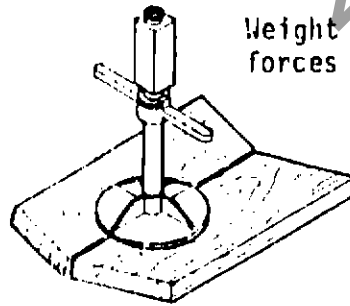
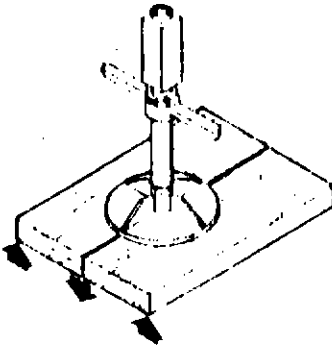

Weight on two blocks
forces down on middle.

CORRECT

Cross blocking distributes
weight evenly.

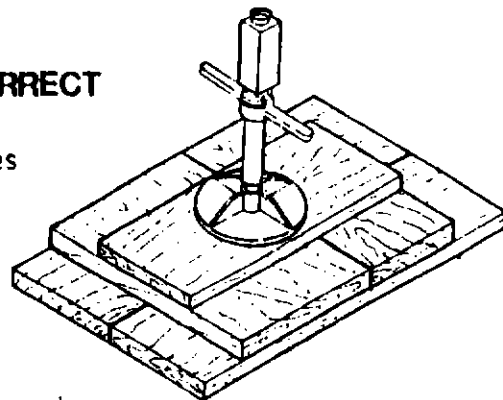

50
Hairpins ("R-Pins") are expendable parts. After repeated use, they become worn and "sprung" as shown in the illustrations below. Never attempt to bend a hairpin back into shape. REPLACE IT WITH A NEW PART.

NEW

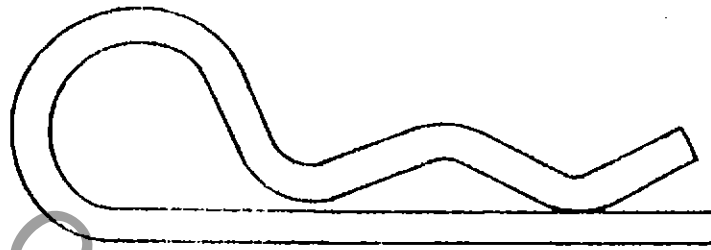

50
ACCEPTABLE

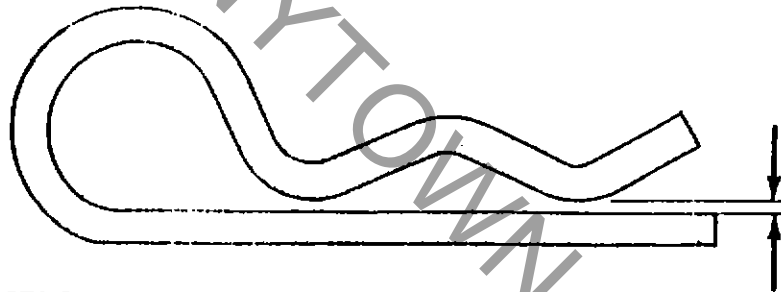

REPLACE

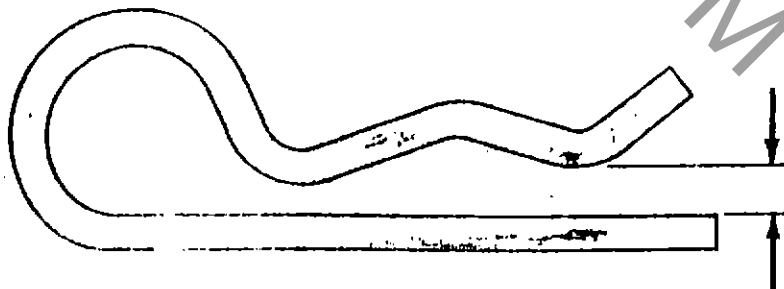

The correct installation of a hairpin is shown below. Incorrectly installed hairpins are more likely to come off the pin, and will become distorted and "sprung" after only a few uses, requiring early replacement.

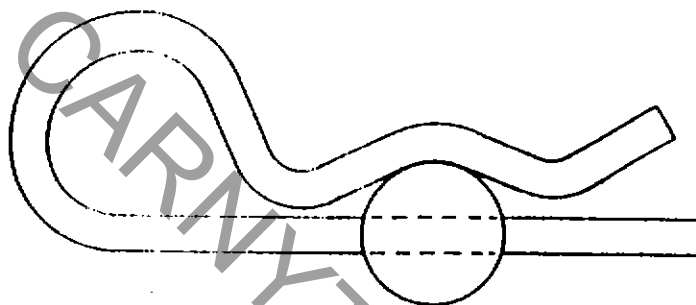

CORRECT

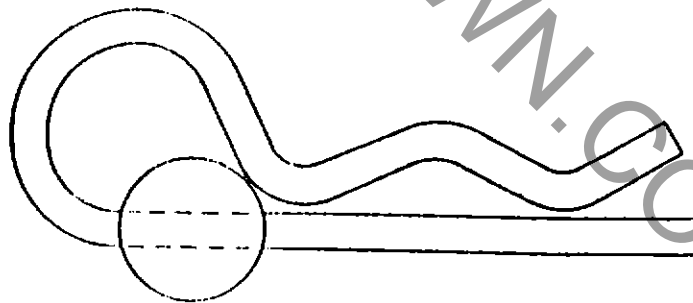







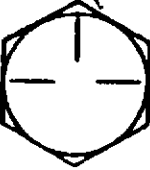

WRONG

GRADE MARKINGS

For Functional Load Carrying Capscrews

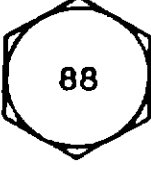
Manufacturer's identification symbols must be present on all capscrews.

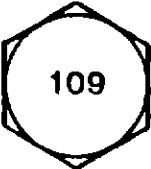
CORRECT MARKINGS	UNACCEPTABLE MARKINGS
<p>SAE J429 GRADE 5 MEDIUM CARBON 81,000 YIELD</p> 	<div style="display: flex; justify-content: space-around;"> <div style="text-align: center;">  GRADE 5.1 LOW CARBON </div> <div style="text-align: center;">  GRADE 5.2 LOW CARBON MARTENSITIC </div> </div>
<p>ASTM A325 TYPE 1 MEDIUM CARBON LONGER SHANK & SHORTER THREAD LENGTH THAN GRADE 5 81,000 YIELD</p> 	<div style="text-align: center;">  ASTM A325 TYPE 2 LOW CARBON MARTENSITIC </div>
<p>ASTM A 325 TYPE 3 CORROSION RESISTING LONGER SHANK & SHORTER THREAD LENGTH THAN GRADE 5 81,000 YIELD</p> 	<p style="text-align: center;">ASTM A325 TYPE 2 LOW CARBON MARTENSITIC</p>
<p>SAE J429 GRADE 8 MEDIUM CARBON 130,000 YIELD</p> 	<div style="display: flex; justify-content: space-around;"> <div style="text-align: center;">  8.8 </div> <div style="text-align: center;"> <p>ISO R898 CLASS 8.8 MEDIUM CARBON 92,000 YIELD</p>  88 </div> </div>
<p>ASTM A490 ALLOY STEEL LONGER SHANK & SHORTER THREAD LENGTH THAN GRADE 8 130,000 YIELD</p> 	<div style="display: flex; justify-content: space-around;"> <div style="text-align: center;">  10.9 </div> <div style="text-align: center;"> <p>ISO R 898 CLASS 10.9 ALLOY STEEL 130,000 YIELD</p>  109 </div> </div>

Torque Chart

TORQUES FOR FUNCTIONAL LOAD CARRYING COLD FINISHED HEX HEAD CAPSCREWS WITH ROLLED THREADS, USED WITH LOCKNUTS (SEE NOTE 3), AND TIGHTENED WITH AN A325 HARDENED WASHER UNDER THE CAPSCREW OR LOCKNUT HEAD (WHICHEVER IS SIBLE FOR TIGHTENING).

THIS TORQUE RANGE WILL DEVELOP 60% TO 70% OF PROOF LOAD.

REFER TO "REPLACEMENT OF CAPSCREWS AND LOCKNUTS" FOR CONDITIONS REQUIRING REPLACEMENT.

SIZE DIAMETER - THREADS/ INCH	FOOT POUND TORQUE RANGE (SEE NOTES 1 AND 2) WITH LOCKNUT AND HARDENED WASHER	
	SAE J429 GRADE 5 ASTM A325	SAE J429 GRADE 8 ASTM A490
1/4 - 20	5-6	7-8
1/4 - 28	6-7	8-10
5/16 - 18	11-13	15-18
5/16 - 24	12-15	17-21
3/8 - 16	19-24	27-33
3/8 - 24	22-27	31-38
7/16 - 14	30-35	45-55
7/16 - 20	35-40	50-60
1/2 - 13	50-60	65-80
1/2 - 20	55-65	75-90
5/8 - 11	95-115	130-160
5/8 - 18	105-130	150-180
3/4 - 10	165-200	235-285
3/4 - 16	185-225	260-320
7/8 - 9	270-325	380-460
7/8 - 14	295-360	415-505
1 - 8	400-490	565-690
1 - 12	440-535	620-755
1-1/8 - 7	495-600	800-975
1-1/8 - 12	555-675	900-1095
1-1/4 - 7	700-850	1135-1380
1-1/4 - 12	775-940	1255-1525
1-1/2 - 6	1215-1480	1975-2395
1-1/2 - 12	1370-1660	2220-2700

NOTES:

1. USE ANTI-SEIZE LUBRICANT ON CAPSCREW SHANK WHEN TIGHTENED FROM HEAD END.
2. USE 10% LESS TORQUE WHEN ANTI-SEIZE OR OTHER LUBRICANT IS USED ON THREADS.
3. USE SAME TORQUE RANGE FOR HOLES TAPPED IN STEEL.

Oct. 16/96

1. Tested Kangaroo at 1600 lbs.
Dead wt. Riel Raw o.k.

2. Tested Riel off 'em at $1\frac{1}{2}$ min Riel
Raw o.k.

3. Tested Riel off Balance load of 800 lbs.
Riel Raw o.k.

4. Tested Riel with 16 people live at
150 lbs. approx. Riel Raw o.k.

by G. L. Co. S.W.C.
G. L. Co.