

OPERATION & MAINTENANCE MANUAL

'Touchdown - 6 Car'

Manufactured by: A.R.M. (UK) LTD.
Unit 1, Enstone Airfield
Enstone
Oxfordshire
OX7 4NW
England

Tel: +44 (0) 1608 677468

Fax: +44 (0) 1608 678765

E-Mail: sales@armuk.demon.co.uk

A.R.M. (U.K.) Ltd.

'Touchdown - 6 Car' Operation & Maintenance Manual

CONTENTS

	<u>Page</u>
Section 1. Type Designation.....	2
Section 2. Design Specification	3
Section 3. Set up Procedure.....	7
Section 4. Operation Procedures.....	18
Section 5. Testing and Inspection	25
Section 6. General Maintenance	41
Section 7. Hydraulic Maintenance	44
Section 8. Service Bulletins	54

SECTION

1

A.R.M. (U.K.) Ltd.

'Touchdown - 6 Car' Operation & Maintenance Manual

TYPE DESIGNATION

Type designation	Touchdown - 6 Car
Serial number	MTD1/10/10/97USA
Month of Manufacture	October
Year of Manufacture	1997
Manufacturer	ARM UK LTD

DESIGNATION

A.R.M. (U.K.) Ltd.

'Touchdown - 6 Car' Operation & Maintenance Manual

DESIGN SPECIFICATION

CARNYTTOWN.COM

	<u>Page</u>
Dimensions, weights, pressures	4
Overall dimensions (diagram 2.1)	5
Maximum bolt torque's	6

SECTION 2

DIMENSIONS, WEIGHTS, PRESSURES

Max length.....	travelling	16000 mm (52ft 6ins)
Max length.....	erected	18300 mm (60ft)
Max width.....	travelling	2590 mm (8ft 6ins)
Max height.....	travelling	4100 mm (13ft 6ins)
Max overall width.....	erected	12800 mm (42ft)
Max height swept by car.....	erected	11250 mm (36ft)
Max height top of machine.....	erected	11250 mm (36ft)
Max height of decking.....	erected	2425 mm (8ft)
Max inclination of decking.....	erected	5 degrees
Max width of each seat.....	erected	450 mm (1ft 6ins)
Max car length.....	erected	1524mm(5ft)
Max mass gross.....	travelling	25000 kg (55100 lbs)
Max number passengers per car.....	erected	4
Max passenger mass per car.....	erected	308 kg (678 lbs)
Max passenger mass total.....	erected	1850 kg (4080 lbs)
Max total mass of machine.....	erected	26850 kg (59180 lbs)
Max design speed of rotation.....	15 rpm	
Direction of rotation of centre.....	clock or anti clock	
Max angle of tilt.....	55 degrees	
Max acceleration of passenger.....	3.0 G	
Max recommended passenger ride time.....	3.0 min	
Min passenger height.....	1270 mm (50 ins)	
Max imbalance on opposite sides of ride.....	5 passengers	
Max pressure in hydraulic system.....	175 bar (2500 psi)	
Min pressure in pneumatic brake system.....	8 bar (116 psi)	
Min time to accelerate full load to full speed.....	15 secs	

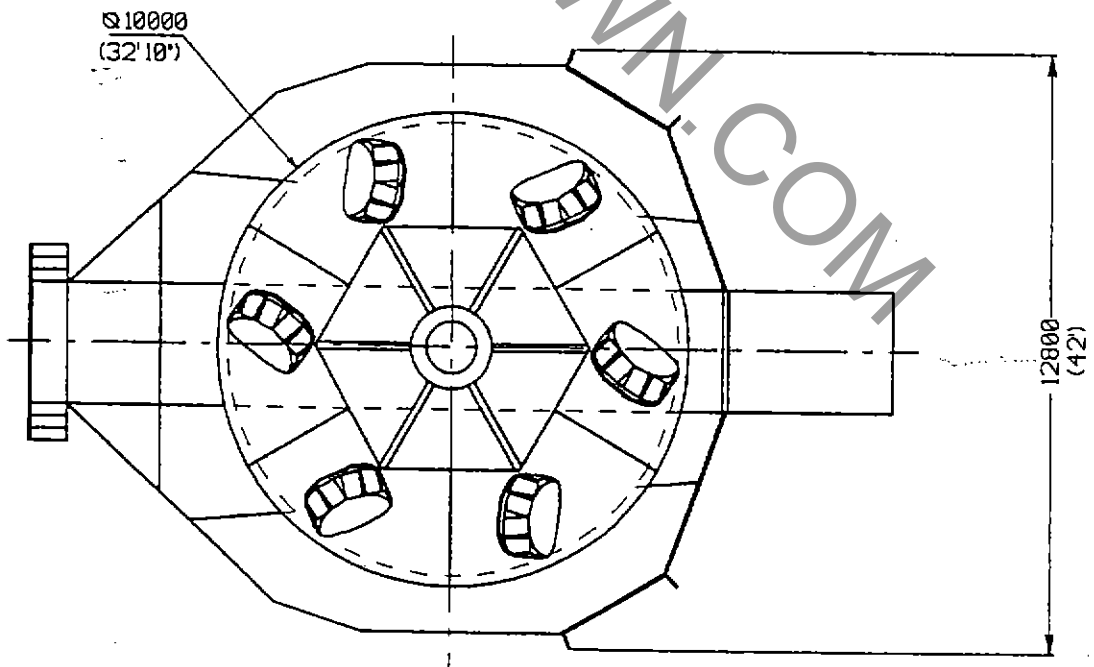
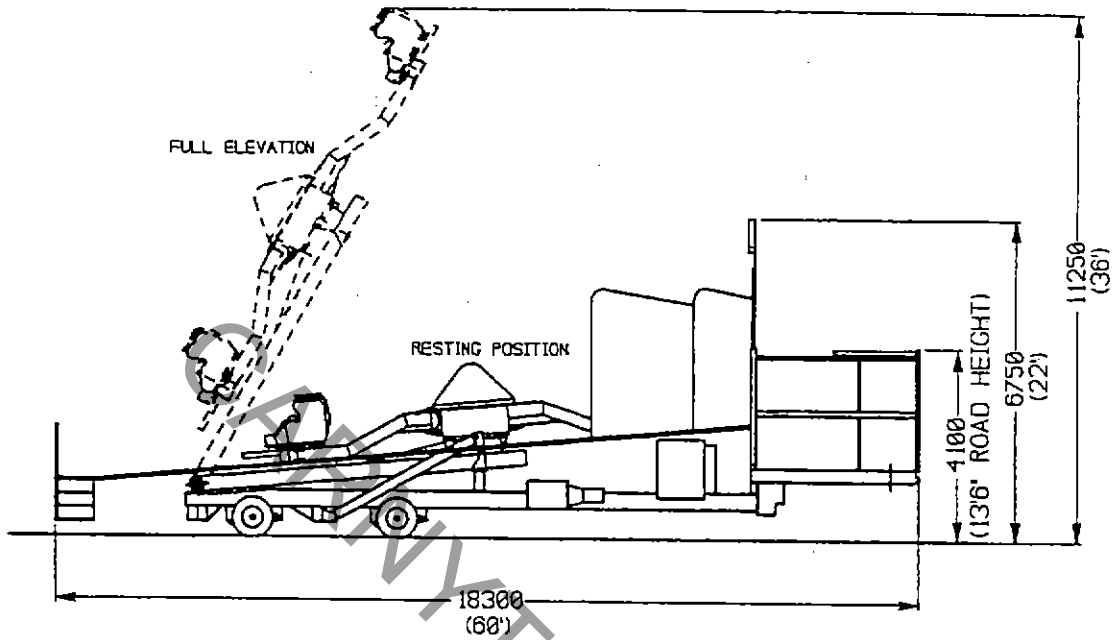

DIAGRAM [2.1] OVERALL DIMENSIONS

SECTION 2

I.S.O. (Grade 8.8) BOLT MAXIMUM TORQUES based on 85% proof stress

Permissible pre-stressing tightening torque's for bolts - property class 8.8.
(as supplied by EC3) DO NOT EXCEED.

<u>Thread Size</u>	<u>Torque (Nm)</u>	<u>Torque (lb.ft)</u>
M6	11	9
M8	28	21
M10	56	41
M12	98	72
M16	244	180
M20	476	351
M24	822	606
M30	1633	1204
M36	2854	2105

Note:

Torques shown are for bolts in the un-plated condition with marginal lubrication only and using flat washers under the mild steel nut. Torques to be re-checked after running ride empty for three minutes to allow for bedding of threads and washer etc.

A.R.M. (U.K.) Ltd.

'Touchdown - 6 Car' Operation & Maintenance Manual

SET UP PROCEDURE

CARNTOWN.COM

	<u>PAGE</u>
Levelling the Trailer.....	8
Correct height of chassis (diagram 3.1)	9
Lowering the floors.....	10
Erecting the Backflash	12
Erecting the Arms	13
Fitting platform centre - handrails	13
Fitting arm in-fill panels	13
Fitting handrails, posts & light up footballs.....	14
Setting up the car hoist and jib-rig	14
Fitting the cars to the arms	15
Fitting PVC skirting	16
Fitting handrails.....	16
Fitting arm in-fill panels.....	17
Fitting floodlights	17

LEVELLING THE TRAILER

- 1) Check site for flatness, very soft ground etc. In particular ensure that the machine is to be set up so that the main outriggers and chassis supports are on good flat ground.
Note: Failure to do this could result in the front end moving during operation producing a sway at the top of the ride.
- 2) Position trailer.
- 3) Connect to power supply.
- 4) Position the steel jack pads under rams. On soft ground use spreader sheets / timber to distribute load.
- 5) Lower hydraulics at the tractor end of the trailer.
- 6) Remove tractor.
- 7) Lift back end of trailer using the pair of back rams to remove load from axles.
- 8) Carefully lower both front rams so that the front of the ride is at the correct height
- 9) Using a spirit level ensure that the front of the ride is level.
- 10) Use the back pair of rams to raise or lower the ride lengthways to the correct ride height (see diagram [3.1]).
- 11) Level back of trailer by putting a spirit level on the back chassis cross member.
- 12) Pull out all four outriggers and insert pins to lock in position.
- 13) Screw down all the screw jacks.
- 14) Position jacks under the jacking points on the trailer chassis. See diagram [3.1]
- 15) Pack ride at the packing points labelled on diagram [3.1].
- 16) Check ride is level and at the correct angle a short while after doing this' procedure to allow for soil sinking, ram creepage etc.

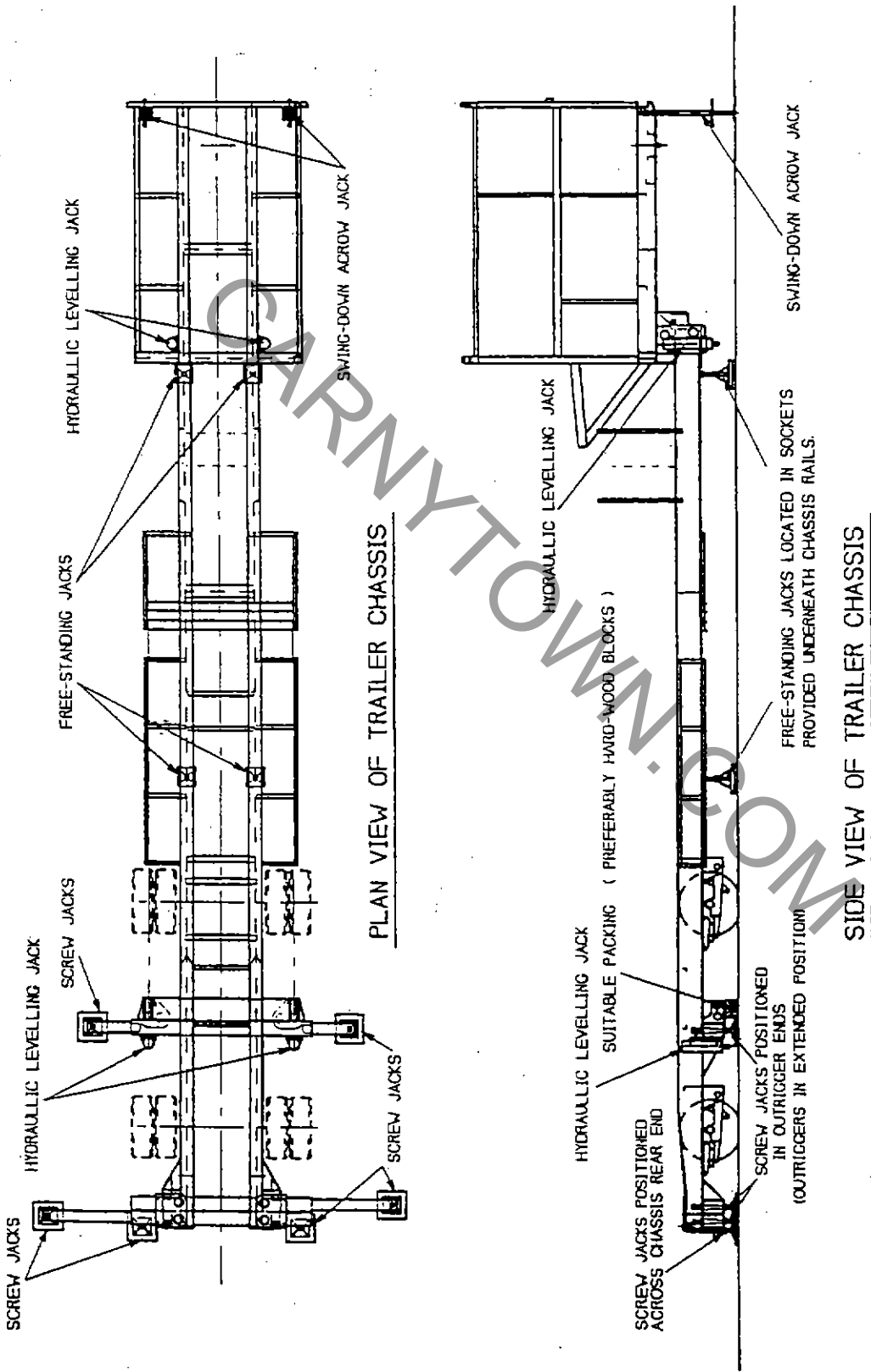

fig. 3.1 LAYOUT OF PACKING POSITIONS AND LEVELLING RAMS

NOTE- THIS VIEW SHOWS TRAILER CHASSIS ONLY, ALL OTHER DETAIL OMITTED FOR CLARITY.

REAR FLOOR:

- 1) Making sure that the floor is physically held in position, remove the two fixing bolts positioned in the top corners of the rear floor.
- 2) Carefully and slowly lower the rear floor just enough to allow the two triangular flaps to be folded around and then hold in position while the rear floor is lowered.
- 3) Continue to lower the rear floor until the outside edge is close to being level and then position two jacks underneath to temporarily support the rear floor, and one jack underneath each flap.
- 4) Fit the decorated shutter panel to the outside edge of the rear floor and fit the two stays under the rear floor to hold the shutter in the correct position. Unscrew the two jacks in the shutter until the most outside part of the rear floor is level. Remove the two jacks temporarily positioned under the rear floor and re-set the two jacks holding up the flaps so that they lay flat to the main section of the rear floor.

FOR EACH SIDE:

SAFETY: ALWAYS STAND WELL CLEAR OF FLOORS THAT ARE BEING LOWERED OR RAISED WITH THE WINCH.

- 1) Lift up the centre dome and winch frame and prop in upright position using the winch frame.
- 2) With the winch frame fixed in position now lift the lower part of the centre dome upwards until the dome is level and raised up above the winch frame and then lock in position using the stay provided for this purpose.
- 3) Fix sling to floor using the brackets and pins attached to the sling. Attach the roller wheel to the outside edge of the main floor flap (to enable floor to roll out when lowered to ground).
- 4) Start up the auxiliary hydraulic pump and pay-out the winch cable until the hook can be connected to the sling. Connect the hook and then take up slack cable with the winch.
- 5) Remove the stay that holds the floor to the centre bobbin and also remove any other fixings that hold the floor in position whilst in transport.

- 6) Using the winch, lower the floor slowly until the two sections that are attached to the trailer chassis are level. Place jacks under these two sections of floor in positions marked with coloured dots (corresponding coloured dots are also on jacks).
- 7) Disconnect the winch hook, remove the sling and put ready for the other side. Fix the lifting rig to the outside flap of the main floor using the pin provided.
- 8) Pay-out the winch cable and attach the hook into the lug on the lifting rig. Make sure the cable passes through the cable guide on the lifting rig, then carefully wind in the winch cable and lift up the outside flap of the main floor until level.
- 9) Set jacks up under the floor in all the marked places (coloured dots). Pay-out the winch cable, remove the hook, carefully wind the cable back onto the winch drum ensuring the cable does not bunch-up in just one area of the drum.
- 10) Remove the lifting rig from the floor, and the roller-wheel, and then repeat procedure for the other side of the main floor.
- 11) When both floors are properly set up, lower the centre dome and the winch frame, stow all stays, the sling and the lifting rig in the belly boxes on the chassis.

FRONT STEPS:

- 1) The two sets of front steps are packed on the trailer chassis behind the swan-neck and next to the oil tank. Unfasten the road fixings and take the steps to the front of the ride.
- 2) Fit each set of steps using anti-luce fasteners and set steps level with the four small jacks especially provided for this purpose (two jacks per each set of steps).
- 3) Should the drop to the ground from the bottom step be excessive due to an uneven site, then the two pin storage boxes can be up-turned and positioned in a stable and safe manner to provide an extra step.

ERECTING THE BACKFLASH

- 1) Unfasten the road clips on the two backflash extension panels that are laid down flat above the top deck of cars on the swan-neck. Lift the panels upright and secure in position using the pins and R-clips provided.
- 2) Unfasten all other road clips and fold round the backflash until it has passed over the outside edge of the main floor and then hold in position.
- 3) Remove the backflash spines from the trailer chassis and fit them and their respective stays to the main floor.
- 4) Push the backflash up to the spines and secure in position using the anti-luce fasteners.
- 5) The remaining three backflash panels cannot be fitted until the cars have been fixed onto the arms of the ride.
- 6) When all the cars have been fitted to the ride and the jib-rig removed, lower the top centre piece of backflash down and fix in position with the anti-luce fasteners and then fit the remaining two centre backflash panels using the anti-luce fasteners provided.
- 7) Locate halogen lamps in the top of the backflash spines and connect the socket and plug.

ERECTING THE ARMS

- 1) Ensure that the bobbin lock is in place.
- 2) Remove cargo straps and any other road fixings.
- 3) Unfold the four non-fixed arms (two each side of trailer) and push them approximately to their positions.
- 4) Unfold the tie bars that are attached to the arms, open them out, connect them to the corresponding arms and insert the pins and R-clips. Also insert the pins in the centre on each tie-bar that lock the tie-bars in the fixed position.
- 5) Tension the arms by tightening the two screw adjusters. Great care must be taken to ensure an even tension either side of the fixed arm divide.
- 6) Next, take the platform bow-strings (packed next to trailer chassis) and insert them into the sockets on the end of the arms.
- 7) Remove road bracket from one pair of platforms and carefully lower the platform into position.
- 8) Repeat for all the other arms and then insert the pins on the inside edge of the platforms and also remove the platform road stays from the arm sockets and stow them safely under the ride.

FITTING PLATFORM CENTRE-HANDRAILS

- 1) Platform centre-handrails are not specifically numbered and therefore can be fitted in any order. They are stored for road transport near the oil tank on one side of the chassis.
- 2) Remove all road fastenings and pass the handrails up to the centre platform, locate the handrail uprights into the pockets situated on the inside edge of the centre platforms.

FITTING ARM IN-FILL PANELS

- 1) Arm in-fill panels are stored on the trailer chassis directly in front of the oil tank and are removed from the opposite side of the chassis to the platform centre-handrails.
- 2) Remove all road fastening clips. Pass the in-fill panels, one at a time, up to the channel slots on the arms, slide the panels up the channel slots until the fixing tubes line up with the corresponding brackets on the centre platforms. Insert pins and R-clips.

HANDRAILS, HANDRAIL POSTS & LIGHT UP FOOTBALLS

- 1) All the handrails and handrail posts are marked with either numbers or letters and must be fitted in the correctly marked position.
- 2) Handrail posts are stored under the ride on the trailer chassis just forward of the two main drive motors and pumps. Remove all fastening straps and fit the handrail posts to the outside edge of the main floor.
- 3) Handrails are stored on a rack positioned on the floor of the ride (at the rear of the trailer). Fit handrails taking care to match numbers / letters correctly with the handrail posts.

Note: The operator control console is held in the upright position by a handrail that connects between the console and the handrail fitted at the very front of the ride directly above the decorated panel.

SETTING UP THE CAR HOIST AND JIB-RIG

- 1) On the top of the top deck of car packing frames at the front end of the trailer is a frame for part of the car Jib-rig. Standing in a secure position, push this frame up to the upright position and lock in place using the two pins provided.
CAUTION: Never be tempted to check alignment of this, or any other holes, by inserting a finger into the hole to feel for any misalignment.
- 2) Fix the two stays that strengthen the front jib-rig frame to the top rail of the car packing frame, and insert the R-clips.
- 3) Using the hand operated winch, raise the other car jib-rig frame and top sign and when fully upright insert the two locking pins and R-clips.
- 4) Un-clip the lower corners of the decorated panel situated inside the jib-rig / top sign frame and prop up level using the prop especially provided for this purpose.
- 5) Lift the aluminium 5-bar tread platform up to the upper most rails of the car packing frame and locate it properly between them and close to the jib-rig frame (the one with the top sign attached).
- 6) Lift the aluminium I-beam car jib up to the top of the car packing frame.
CAUTION: Take care that the trolley does not suddenly roll along the I-beam and crush fingers - handle I-beam by the top flange.
- 7) Lift up the end of the I-beam nearest the front of the trailer and insert the pin in the hole in the frame.

- 8) Standing on the aluminium 5-bar tread platform, lift up the middle of the I-beam and secure in position on the frame directly above using the pin provided for this purpose. Now push the R-clip through the pin at the other frame where the pin was inserted into the hole.
- 9) Next add the 'monkey' frame to the jib (this consists of a post with two adjustable cables) by inserting the post into a pocket positioned on the top of the frame, directly above where the middle of the I-beam was pinned.
- 10) Attach the two cables to their respective brackets at either end of the I-beam and tension the cables using the rigging screws provided.
- 11) The hoist is stored in one of the cars on the top deck, lift the hoist up and attach it to the trolley.

FITTING THE CARS TO THE ARMS

- 1) In order to fit the cars to the arms it is necessary to rotate the platform. Before starting the ride up it is important that the operator has read the operating instructions and is familiar with all the controls and their functions, and is aware of all safety recommendations. Before starting this ride it is important to check that nobody is working underneath the ride in an area not visible to the operator from his control console.
- 2) Check which number car is on the top row nearest the centre of the ride, find the corresponding arm and then move the platform round (using the controls on the operator console) until the arm is lined-up with the Aluminium I-beam that forms the carriage way of the jib-rig.
- 3) Connect the straps of the sling onto the car to be fitted by attaching the loops onto the metal hooks underneath the car (2 at the front of the car and 2 at the rear). Lower the lifting hook of the chain hoist until it reaches the metal ring of the sling. Connect it to the ring and then carefully take the weight of the car with the hoist and lift it up off the frame.
- 4) Taking care not to let the car collide with the sides of the opening in the backflash, push the car towards the arm socket until it is directly above the socket.
- 5) Lower the car until the insert is just above the socket. Check that the 'rough loaders' on the flange of the insert are approximately lined-up with the arm (the side nearest the bobbin from the socket) and turn if necessary, lower the car so that the insert engages with the socket and that the flange of the socket is properly sat down on the arm. Check that the 'rough loaders' are one each side of the arm.
- 6) Insert the 4 pins and secure each pin with the R-clips provided. Connect the electrical plug and socket and also connect the male to female air coupling.
- 7) Ensure that all persons are clear from underneath the ride and then rotate the platform 180° so that the next car to be fitted is directly opposite the one that has just been fitted.

SECTION 3

- 8) Remove the packing frame that the previous car fitted was loaded on and stow it safely underneath the ride.
- 9) The next car to be fitted is the same deck (top) car nearest the centre of the ride. Check to make sure that the car number corresponds with the arm number, then repeat steps 3 to 6 inclusive.
- 10) The next car to be fitted (the third car) is the last one on the top deck. First check car number and find the corresponding arm number, ensure that all persons are clear from underneath the ride and then turn the platform (using the controls on the operator console) until this arm is in line with the jib-rig.
- 11) Remove the packing frame that the previous car was loaded on and stow it away safely underneath the ride.
- 12) Repeat steps 3 to 8 inclusive.
- 13) The next car to be fitted is lower deck nearest to the centre of the ride. Check that the next car and arm numbers correspond then repeat steps 3 to 6.
- 14) The next car to be fitted (the fifth car) is the middle one on the lower deck. First check the car number and find the corresponding arm number, ensure that all persons are clear from underneath the ride and then turn the platform (using the controls on the operator console) until this arm is in line with the jib-rig.
- 15) Repeat steps 3 to 8 inclusive.
- 16) Repeat steps 3 to 6 inclusive.
- 17) Dismantling of the jib-rig is the reverse of the assembly procedure (see page 14 titled "Setting up the car hoist and jib-rig"). Stow the jib-rig and car hoist in a safe place underneath the ride.
- 18) Fit the piece of floor to complete the peripheral walkway over the hole where the cars have been stored for road transport. Also fit the last 2 pieces of backflash using the anti-luce fasteners provided so that the access to the car packing area is closed off.

FITTING PVC SKIRTING

- 1) The PVC skirting that screens and prevents access of the general public to the underneath of the ride consists of five separate pieces of PVC material. Four pieces are attached to the outside edge of the floor and steps (2 per side) using a combination of turnbuckle clips and velcro strips (hook & loop fastening strips), and the final piece is fitted around the trailer swan-neck in a similar manner.

FITTING HANDRAILS

The handrails are all numbered and should each be fitted between the corresponding numbered pockets.

FITTING ARM INFILL PANELS

The in-fill panels are fitted by rotating the ride so that the correct gap between the arms is over where the panels are stored on the trailer. Lift and slide the panels into the channel slots on the arms, pin and R-clip.

FITTING FLOODLIGHTS

- 1) Position all the upright tubes ensuring that they are fully slid into their respective holding tubes on the chassis.
- 2) Use the crane and hooking points provided to lift the floodlight units and carefully drop the mounting into the upright tube.

Note: care should be taken by the crane driver and person guiding the floodlight units into their housing to avoid trapping hands between the unit and tube when lowering the unit

SECTION

4

A.R.M. (U.K.) Ltd.

'Touchdown - 6 Car' Operation & Maintenance Manual

OPERATING PROCEDURES

	<u>PAGE</u>
Operating procedures	19
Layout of control panel (diagram 4.1)	21
Loading / Unloading of passengers.....	22
Emergency procedures.....	23
Wind speed precautions	24

OPERATING PROCEDURES

Diagram [4.1] is a plan view of the control panel.

Note: Before operating the ride ensure that the operator is familiar with all the control systems.

Before operation:-

- 1) Carry out daily inspection of structure.
- 2) Carry out daily maintenance.
- 3) Ensure that the bobbin lock pin is removed.
- 4) Check that the crane hydraulic pipes have been removed.

To operate:-

- 1) Switch on the compressor
- 2) Switch on the hydraulic pump
- 3) Check that all lap bar restraint mechanisms are down and locked. This must be done by a physical check on each lap bar.
- 4) It is important to ensure that the ride is not run in an imbalanced state ie. when running less than a full load of passengers, load the passengers in opposite gondolas to balance the ride
- 5) Insert the key and turn the key switch to the 'ON' position.
- 6) Turn the Lift Motor switch to the 'ON' position.
- 7) Turn the Platform Motor switch to the 'ON' position.
- 8) To rotate the platform turn the 'Platform Rotate' switch to the 'ON' position.
- 9) To control the speed and direction of the platform as desired, turn the knob directly below the 'Platform Rotate' switch.
- 10) To stop the platform rotating, turn the 'Platform Rotate' switch to the 'OFF' position.

SECTION 4

- 11) To apply the platform brake turn the 'Platform Brake' switch to the 'ON' position.
- 12) To release the platform brake turn the 'Platform Brake' switch to the 'OFF' position.
- 13) To raise the boom turn the 'Raise' switch to the 'ON' position.
- 14) To stop the boom raising at any time during it's journey to the maximum height position turn the 'Raise' switch to the 'OFF' position and it will remain in this position until the switch is turned to the 'ON' position. However, it is not recommended for the boom to be held for long periods of time in any position other than fully up or down.
- 15) To lower the boom turn the 'Lower' switch to the 'ON' position.
- 16) To stop the boom lowering at any time during it's descent to the resting position turn the 'Lower' switch to the 'OFF' position and it will remain in this position until the switch is turned to the 'ON' position. However, it is not recommended for the boom to be held for long periods of time in any position other than fully up or down.
- 17) To operate the car brakes (for loading / unloading of passengers) turn the 'Car Brakes' switch to the 'ON' position.
- 18) To release the car brakes (after all passengers are loaded) turn the 'Car Brakes' switch to the 'OFF' position.
- 19) To obtain the best operation manually take the ride to full height, near full speed and slow ride down until the cars flip. After finding this critical speed slightly increase the speed for a few revolutions and then do the same for a speed just slightly slower than the critical speed. This ensures that all the cars will experience the "Touchdown flip" despite the different weights of the passengers in each car.

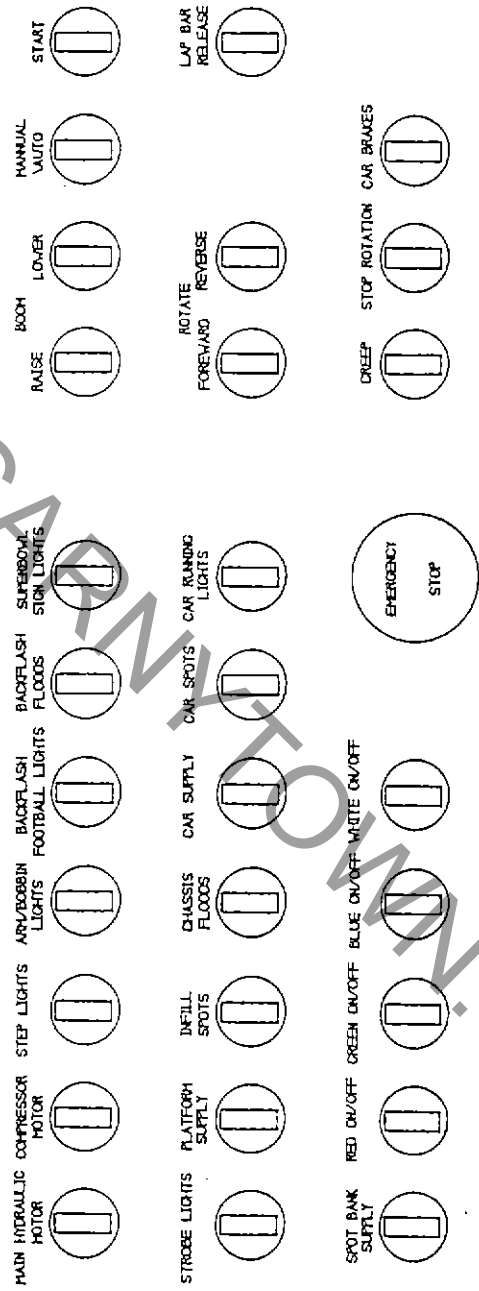

DIAGRAM [4.1] LAYOUT OF CONTROL PANEL

LOADING / UNLOADING OF PASSENGERSTouchdown Passenger Safety

To release passengers and/or open safety bar.

To release the passengers from the car and to open the safety bar press both pedals down at the same time and lift the safety bar upwards, (the pedals are located at the outside front edge of the car - see Fig. 4.2)

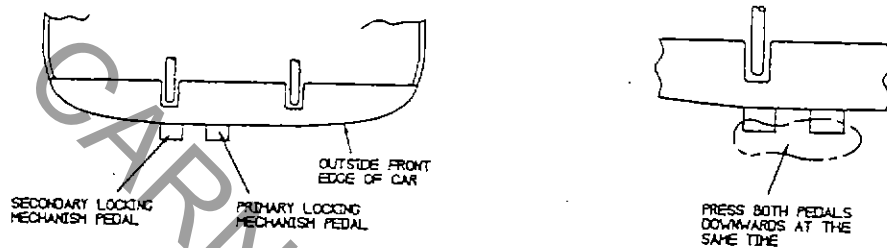

Figure 4.2

To load passengers and / or close safety bar.

Ensure that the passengers are properly sat down and then carefully lower the safety bar until both pedals are fully up, (see Fig. 4.2). Check the security of the safety bar by attempting to open the bar upwards after both pedals are up.

NOTE: It is of the utmost importance that both locking mechanisms are fully engaged before the ride is started. It is the responsibility of the operator to visually and physically carry out these checks every ride.

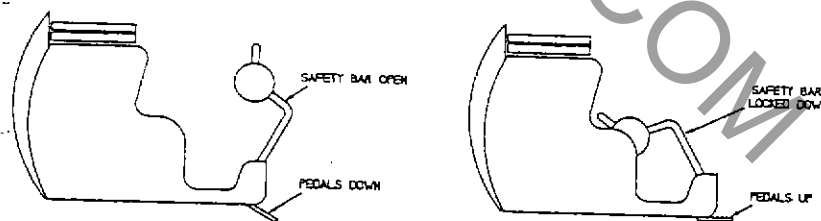

Figure 4.2

EMERGENCY PROCEDURES

In the case of the following:-

Electrical generation fault or failure.
Passenger attempting to get out of car.
Structural deflection.
Any abnormal noises.
Sudden bad weather eg. wind, hail or lightening.
Lap bars coming loose.
etc.

Then the ride must be stopped and let down immediately. This can be achieved either by switching to manual control and slowing the ride down and also lowering it with button control.

In the case of an urgent problem the 'Emergency Stop' button should be pressed. The platform will stop rotating and the platform brake will be automatically applied. If the boom is in 'Raise' or 'Lower' mode it will stop immediately in it's current position.

If the control panel is not working properly eg. it will not lower the ride, then press the emergency stop button and locate the main spool valve situated approximately in the centre of the trailer chassis, approximately mid-way between the front and rear of the trailer. Lower the ride by shuttling the spool valve across by hand using the button provided.

Lapbars can be manually released by using the foot pedal located at the base of each car.

SECTION 4

WIND SPEED PRECAUTIONS

In the event of wind speed exceeding 40 MPH (see scale provided to approximate wind speed) the ride must not operate.

In the event of wind speed exceeding 60 MPH (see scale provided) it is suggested that the backflash is lowered and the sign folded up and swung back behind the ride. These precautions will prevent instant damage and may also prevent failure in the future due to inherent structural damage.

BEAUFORT SCALE FOR WIND ESTIMATION

Note: The following scale will give the ride operator an indication of the wind speed in an open area. The scale is only for an approximate wind speed and if in doubt contact the local weather centre for a more accurate reading / forecast.

<u>Beaufort Number</u>	<u>Description</u>	<u>mph</u>	<u>Wind Speed Observed effects</u>
0	calm	0	smoke rises vertically.
1	light	14	direction of wind shown by smoke drift.
2	light breeze	4-7	wind felt on face.
3	light breeze	7-12	light flags extended.
4	moderate breeze	12-17	raises dust and loose paper.
5	fresh breeze	17-20	small leaf sway.
6	strong breeze	21-31	large branches sway, whistle in telegraph wires.
7	near gale	32-38	whole trees in motion, difficult to walk.
8	gale	38-46	twigs break off trees.
9	severe gale	47-54	slates begin to fall.
10	storm	55-63	trees uprooted.
11	severe storm	64-72	extensive damage.

A.R.M. (U.K.) Ltd.

'Touchdown - 6 Car' Operation & Maintenance Manual

TESTING AND INSPECTION**DAILY INSPECTION**

Trailer.....	26
Decking.....	26
Arms.....	27
Cars.....	27
Boom and Drive system.....	28
Bobbin.....	28
Chassis.....	28
Hydraulic system.....	29
Pneumatic system.....	29
Handrails and other fixings.....	29
Daily No Load, Full Height and Full Speed Test.....	29

WEEKLY INSPECTION

Trailer.....	30
Decking.....	30
Arms.....	30
Cars.....	30
Drawing of Locking mechanisms Diag [5.1].....	31
Boom and Drive System.....	32
Bobbin.....	32
Chassis.....	32
Hydraulic system.....	32
Pneumatic system.....	32

TWELVE MONTHLY INSPECTION AND TESTING

General.....	33
Structural examination - General.....	34
Structural examination - Safety Critical areas.....	35
Safety Critical areas - Boom (diagram 5.1).....	36
Safety Critical areas - Chassis (diagram 5.2).....	37
Mechanical examination.....	38
Hydraulic examination.....	39
Pneumatic examination.....	39
Test Procedure.....	40

DAILY INSPECTION**TRAILER**

- 1) Check ground for subsidence and water logging. If ground is extremely wet then consult an amusement ride engineer before attempting to run ride.
- 2) Check all packing points on trailer including all the main structures screw jacks to ensure ride is supported correctly.
- 3) Check ride is level. If it is not use levelling rams to correct and then re-check all packing points and screw jacks are fully and evenly supporting the ride.
- 4) Check any hydraulic jacks, screws, securing pins and fastenings.
- 5) Check any hydraulic hoses and fittings.

DECKING (BOTH OUTER FLOORS AND MOVING PLATFORM FLOORS)

- 6) Check full circumference of perimeter fence for security.
- 7) Check both sets of steps and their fixings at the front of the ride for their rigidity and security.
- 8) Check all deck plates for loose screws and protrusions.
- 9) Check all surfaces for loose debris, coins, litter and grease.
- 10) Check for cracks in all decking supporting beams.
- 11) Check all decking supports, jacks, pins, swing out supports are secure.
- 12) Check pins and R-clips in rotating floor are in place and secure.
- 13) Check handrail pocket and platform welds are not cracked or damaged.

ARMS

- 14) Check all cross link pins and R-clips are in place.
- 15) Check all four pins and R-clips are in place for each car.
- 16) Check air line and electrical sockets are firmly plugged in for each car.
- 17) Check key welds at arm kinks and arm fixing tube for any signs of cracks or distortion.
- 18) Check welds at bobbin end of arm.
- 19) Check arm pivot pins (4 off) have split pins securely in position.
- 20) Check arm lighting caps are secure.

CARS

- 21) Check cars for excessive play in the slewing rings by attempting to rock the cars from the back.
- 22) Visually check that the lap-bar foam padding rolls are all in position and that none are missing or damaged.
- 23) Check all lap-bar welds are not cracked.
- 24) Check glassfibre for sharp or rough edges, paying particular attention to the seating area. Also check for any serious cracks in this area.
- 25) Check that the locking mechanism aluminium cover at the front of the car has all the bolts fitted and in place, also that the cover is not loose and is secured properly.
- 26) Check the floor plating of each car for grease or any other slippery substance. If found remove thoroughly.
- 27) Check that both locking mechanisms are working properly, that the pedals are returning correctly when the bar is shut and that there is no play in the lap-bar when locked. Each bar to be tested at least three times in succession - check for smoothness of operation and listen for any unfamiliar noises not normally associated with this procedure.

NOTE: If either or both of the two locking mechanisms is not in perfect working order then the particular car(s) must not be used to ride passengers until the problem has been rectified. If in doubt contact the manufacturer immediately.

SECTION 5

- 28) Generally check car structure both above mounting frame and below by lying on platform and rotating car whilst looking for cracks, debris, damage etc.
- 29) Check that the car brakes are working correctly to hold the car in the parking position. If not, then the particular car(s) must not be used to ride passengers until the problem has been rectified. If in doubt contact the manufacturer immediately

BOOM AND DRIVE SYSTEM

- 30) Check structure for major distortion, buckling etc.
- 31) Check welds for cracks or damage.
- 32) Check motor and gearbox for signs of excess heat or distortion.
- 33) Check cover plate on slewing ring and pinion for security.
- 34) Check all power cabling underneath boom is secure.
- 35) Check Boom pivot blocks have no bolts missing and that the bolts are not loose.

BOBBIN

- 36) Check that the centre dome and centre lighting panels are pinned, R-clipped and secure.
- 37) Generally check all welds and structure for any visible cracks, distortion or damage.
- 38) Check that there all electrical fixing wires, sockets, air pipes and connectors coming from the bobbin are not damaged.

CHASSIS

- 39) Check structure and welds for any distortion, cracks and damage.
- 40) Check all hoses, fittings and cables are secure.
- 41) Check that there is no damage to or debris on the limit switches at the front of the boom.

HYDRAULIC SYSTEM

- 42) Check all hydraulic hoses and fitting for damage and security.
- 43) Check oil tank level and for oil leaks throughout the site in general.

PNEUMATIC SYSTEM

- 44) Check pressure in system is 6 bar.
- 45) Check that the cars are receiving pressure.

HANDRAILS AND OTHER FIXINGS

- 46) Check floodlighting posts and floodlight covers are secure.
- 47) Check all handrails are secure.
- 48) Check all sound system and cables are secure.

DAILY NO LOAD, FULL HEIGHT AND FULL SPEED TEST

- 49) Run machine to full speed and slow down looking for abnormal vibration, noises etc.
- 50) Generally check structure for abnormal wobbles, vibrations, noises or deformation.

SECTION 5

WEEKLY INSPECTION

Carry out all 'Daily Inspection' checks and then proceed with the following:-

TRAILER

- 1) Visually check welds for cracks paying particular attention in the area which is between and includes the boom ram lower pivots and the boom pivots.

DECKING (both outer floors and moving platform floors)

- 2) Check all floor hinges for cracks.
- 3) Check Backflash fixing points for security and check backflash for any loose panels.
- 4) Check the top sign for security.

ARMS

- 5) Check the clearance between the arms and the fixed floor.

CARS

- 6) Remove the locking mechanism inspection cover.
- 7) Check the lap-bar pivot retainers for security.
- 8) Check the primary locking mechanism pin housing for security.
- 9) Check the primary locking mechanism 'Pin tip' for excessive wear or damage.
- 10) Check the primary locking mechanism dog for any tooth damage or excessive wear.
- 11) Check security of the link bar.
- 12) Check all springs are in their correct positions and are functioning properly.
- 13) Replace the locking mechanism inspection cover and remove the car floor panel.
- 14) Check that the brake shoe is not worn out.
- 15) Check that the brake chamber and operating valve are securely mounted.
- 16) Check the brake linkage is working correctly.
- 17) Check that the brush gear is mounted securely.
- 18) Check that all air pipes and wiring is not damaged and that connectors are properly joined.
- 19) Check that there is no evidence of air leakage.
- 20) Replace the car floor panel using the bolts provided.

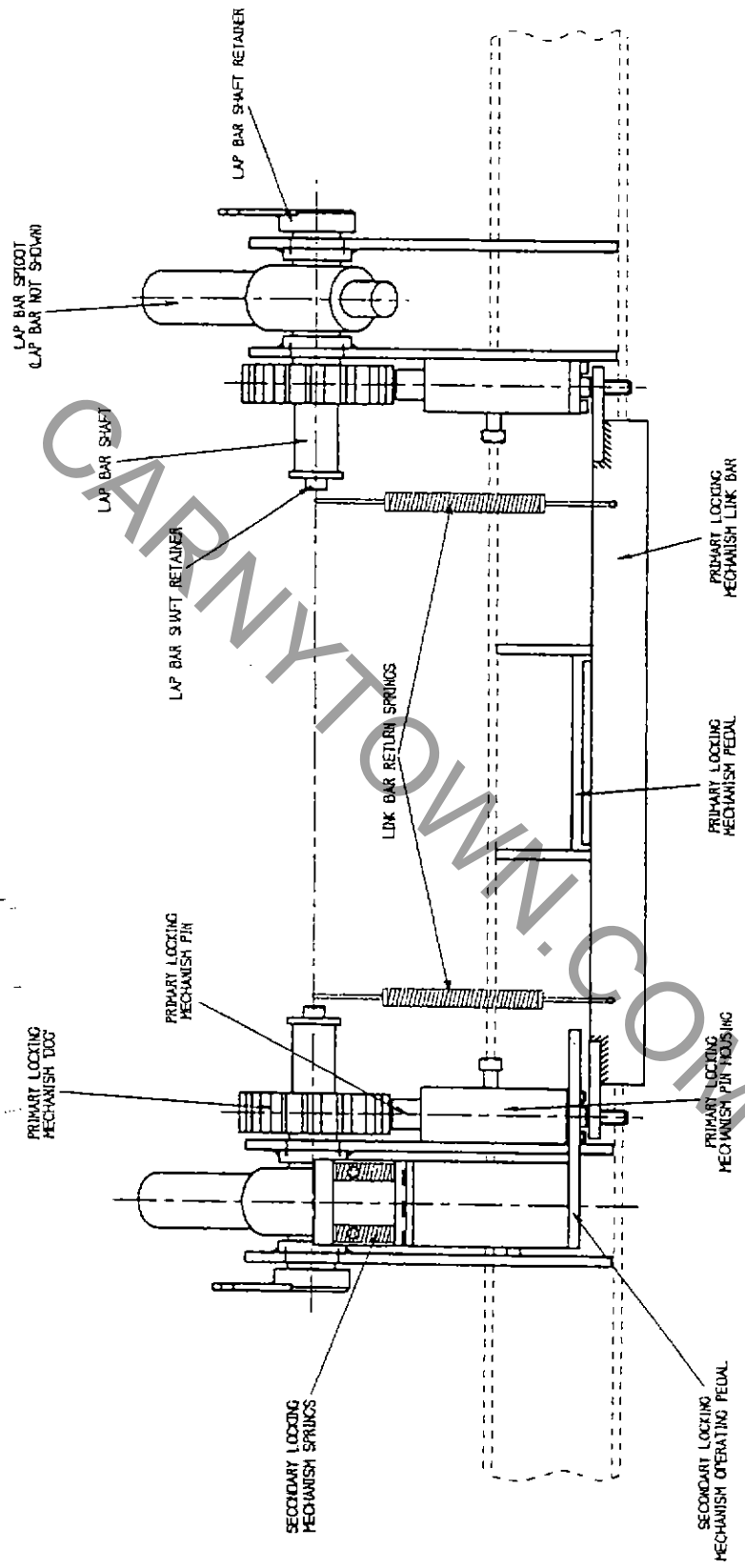

FIG [5.1] LAP BAR PRIMARY & SECONDARY LOCKING MECHANISMS (AS VIEWED WITH INSPECTION COVER REMOVED)

SECTION 5

BOOM AND DRIVE SYSTEM

- 21) Listen during test operation (see section 4) for any signs of squeaking, creaking or grinding around the boom pivot area.
- 22) Check the boom pivot blocks closely for any cracks in the weldments.
- 23) Check for excess play or damage to the thrust washers either side of the boom.
- 24) Check the drive pinion and slewing ring for wear or tooth damage ie. pitting or flaking.
- 25) Check the security of the gearbox output pinion end cap.

BOBBIN

- 26) Lift up the centre dome (see section 3) and check security of the winch.
- 27) Check security of the bobbin weldments that are now accessible due to the dome being lifted.

CHASSIS

- 28) Check all ancillaries mounted on the chassis for secure mounting. This includes both pump and motor assemblies, cooling fan, compressor, and all hydraulic ancillaries.

HYDRAULIC SYSTEM

- 29) Thoroughly check the complete system, including hoses and fittings, for any signs of leakage and/or damage.

PNEUMATIC SYSTEM

- 30) Thoroughly check the complete system, including hoses and fittings, for any signs of leakage and/or damage.

TWELVE MONTHLY INSPECTION AND TESTING**GENERAL**

Every twelve months the machine must undergo a thorough examination by an appointed person who is an independent examiner suitably qualified to undertake this task and preferably having experience of non-destructive testing (N.D.T.) on steel fabrications.

To aid this examination, all weldments not visible by virtue of being masked by other structures must be made visible and reasonable access provided by dismantling, in part, or whole, of the relevant sub-assemblies.

The following are the major areas of the machine to be examined using the appropriate procedures and working to the relevant checklist in a methodical manner

- Structural Examination General
- Structural Examination of Safety Critical areas
- Mechanical Examination
- Electrical Examination
- Hydraulic Examination
- Pneumatic Examination
- Test Procedure Examination

Any defects found, to be noted, and the implications for the integrity of the machine and safe operation to be noted. Any serious structural defects must be communicated to the manufacturer at the earliest opportunity so that suitable rectification methods may be formulated and any necessary design modifications may be incorporated in future machines.

If satisfactory, sign logbook and issue inspection certificate. If not replace unsatisfactory members and test machine as relevant checklist.

- 1) Check all structures for gross deformation and signs of impact.
- 2) Check all connecting pins and bolts for deformation, cracks, surface fretting and correct material grade (EN8). If in doubt discard.
- 3) Check slewing ring bolts for defects, torque, defects and correct material grade. Must be grade 8.8 (see torque chart in Section 2).
- 4) Check structures for corrosion and cracking of parent metal or weldment especially in highly stressed regions in the vicinity of securing and retaining pins and bolts. Use N.D.T. such as dye penetrant test.
- 5) Check deck plates for damage and cracks. If in doubt discard.
- 6) Check any timber fabric for security and damp rot. This includes packing material. If in doubt discard.
- 7) Check any superficial covers for security.
- 8) Check general level of upkeep and comment in writing. Please copy and send to manufacturers for records.
- 9) Check general condition of paint finish and corrosion, ie. superficial or deep corrosion.
- 10) Check for general correctness of assembly, with particular attention to:-
 - securing pins ie. positioned correctly.
 - cross link adjusters in tension.
 - packing under ride.
- 11) Check bolts for correct torques and grades, ie. grade 8.8 (see torque chart in Section 2).

Note: Prior to any inspection for surface defects, cracks etc., clean and degrease thoroughly first.

STRUCTURAL EXAMINATION - SAFETY CRITICAL AREAS

- 1) Safety critical areas must be examined periodically by N.D.T (not more than a year apart)
- 2) Please refer to diagrams [5.1 & 5.2] and report sheets provided for the safety critical areas to be inspected.
- 3) These safety critical areas are to undergo an N.D.T. inspection of parent metal in the direct vicinity of joint weldment or stress raisers indicated.
- 4) The joint weldment must also be given an N.D.T. inspection.
- 5) The inspector is to examine the complete length of these joints.
- 6) It is advised that the appointed person consults expert opinion as appropriate in the following disciplines:-

N.D.T.
Stress analysis
Welding technology

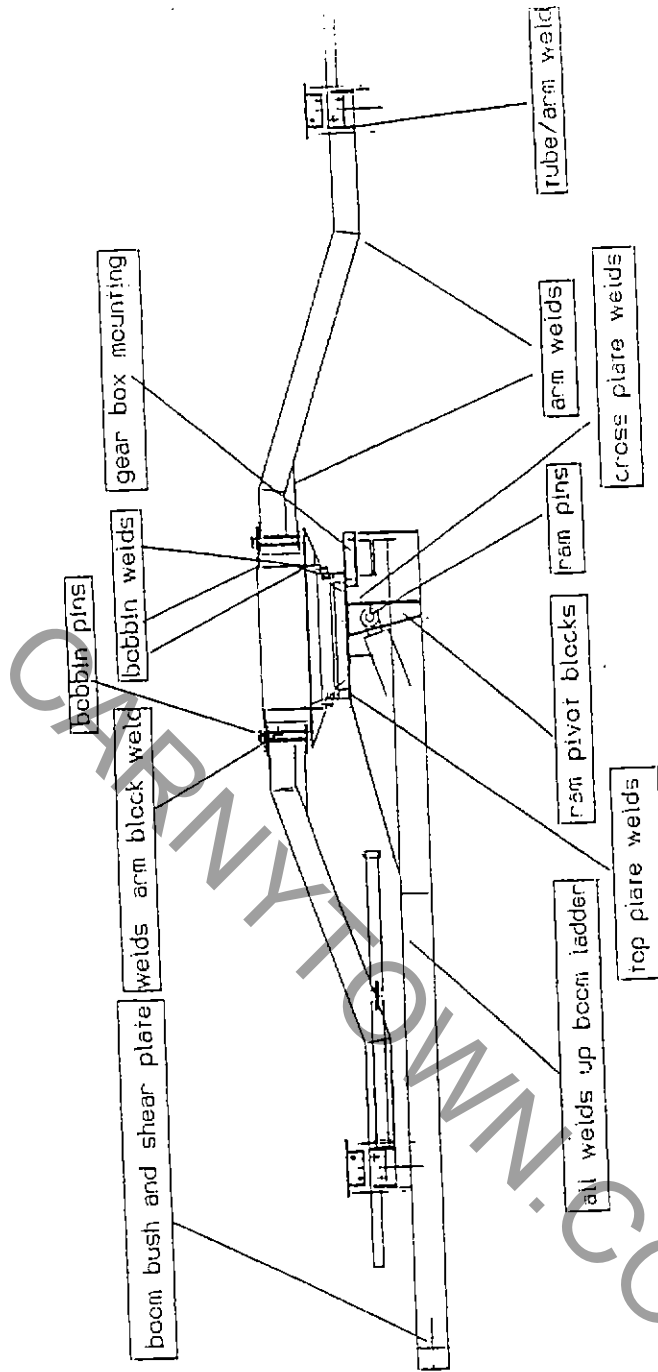

DIAGRAM [5.1] SAFETY CRITICAL AREAS - BOOM

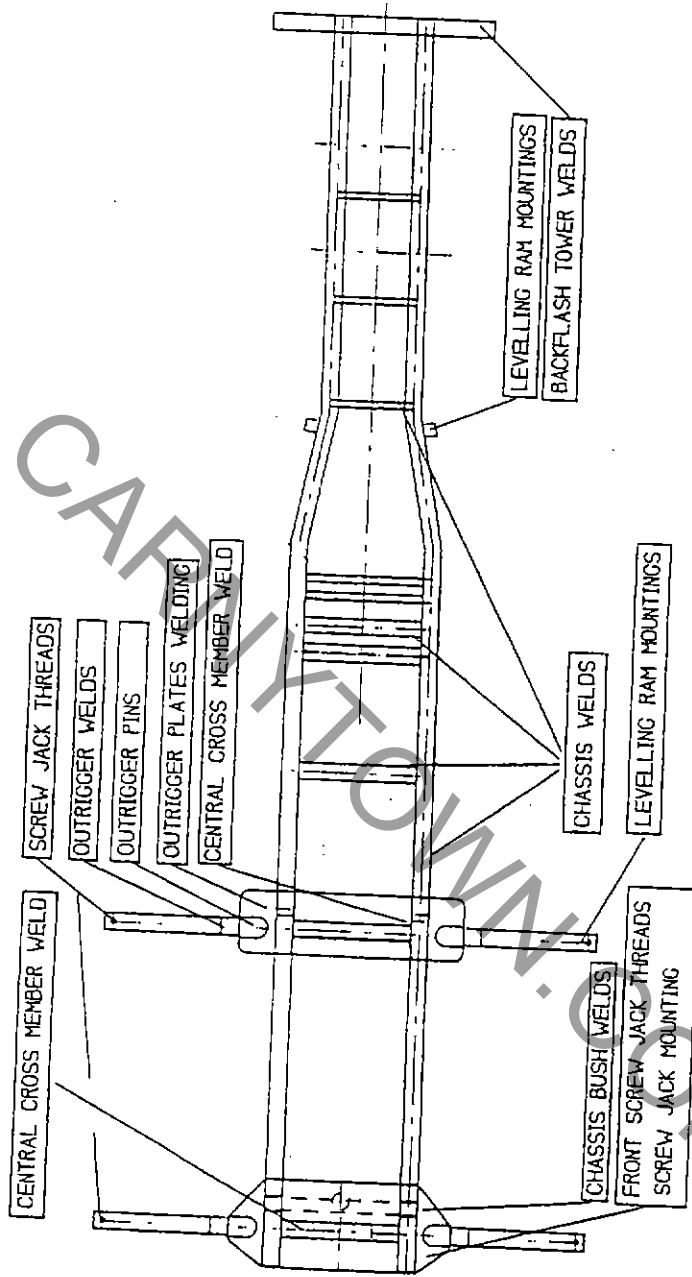

DIAGRAM [5.2] SAFETY CRITICAL AREAS - CHASSIS

- 1) Check slewing rings for roughness in operation, also check for play between races.
- 2) Check slewing rings for adequate greasing and any corrosion.
- 3) Check main slewing ring drive and pinion for pitting, flaking, wear and backlash.
- 4) Check all slewing ring bolts for correct grade (8.8) and torque (see chart in Section 2).
- 5) Remove lap bar mechanisms and check for:-
 - Signs of wear or damage in the linkage pins.
 - Pitting, wear or cracking of ratchet teeth and pawls.
 - Adequate grease in ratchet shafts.
 - Excess grease in pawl shafts.
 - Damage or signs of distortion on the springs.
 - Signs of wear or damage to the emergency release mechanisms.
 - Correct stiffness from the gas struts.
 - Any signs of cracks or damage to the lap bar itself, particularly near or on welds.
 - Security and smooth operation of solenoids.
- 6) Check air brakes on cars for signs or wear or loose parts.
- 7) Check structure of underneath of car and security of electrical boxes such as transformers etc.
- 8) Check all fibre glass in cars for cracks damage etc.

A.R.M. (U.K.) Ltd.

'Touchdown - 6 Car' Operation & Maintenance Manual

GENERAL MAINTENANCE

	<u>PAGE</u>
Daily Maintenance.....	42
Replacement Intervals.....	42
Recommended Lubricants.....	43

SECTION 6

DAILY MAINTENANCE

Areas requiring greasing
(For recommended grease specifications see next page)

- 1) Car slewing rings GP
- 2) Lap bar mechanism GP
- 3) Centre slewing ring EP
- 4) Drive Pinion EP
- 5) Boom Pivot bearing EP
- 6) Arm pivot blocks GP
- 7) Outrigger pivot blocks GP
- 8) Spherical (rose) bearing on each end of rams GP

REPLACEMENT INTERVALS

The replacement cycles to avoid components wearing or breaking are as follows:-

YEARLY REPLACEMENT

- 1) A complete hydraulic oil change.
- 2) Hydraulic oil filters to be replaced.











2 YEARLY REPLACEMENT

- 1) All springs in the lap bar primary and secondary mechanisms. Consult the manufacturer.

10 YEARLY REPLACEMENT

- 1) All sprag clutches (lap bar primary locking mechanisms) to be replaced - 12 units in total. Consult the manufacturer.

RECOMMENDED LUBRICANTS

MANUFACTURER	APPLICATION	AMBIENT TEMPERATURE
 ARAL	G.P. Aralub HLP 2	248K to 403K (-25oC to +130oC)
	E.P. Aralub LFZ 1	253K to 523K (-25oC to +250oC)
 BP	G.P. Energrease LS-EP 2	248K to 403K (-25oC to +130oC)
	E.P. Energol WRL	273K to 353K (-0oC to + 80oC)
 CASTROL	G.P. Spheerol EPL 2	253K to 393K (-20oC to +120oC)
	E.P. Grippa 33 S	253K to 353K (-20oC to +80oC)
 ELF	G.P. Epexa 2	243K to 393K (-30oC to +120oC)
	E.P. Cardrexa DC 1	253K to 393K (-20oC to +120oC)
 ESSO	G.P. Beacon EP 2	248K to 403K (-25oC to +130oC)
	E.P. Surett Fluid 4 k	253K to 373K (-20oC to +100oC)
 KLUBER	G.P. Cenoplex 2 EP	238K to 393K (-35oC to +120oC)
	E.P. Grafloscon CA 901	253K to 423K (-20oC to +150oC)
 MOBIL	G.P. Mobilux EP 2	253K to 393K (-20oC to + 120oC)
	E.P. Mobiltac 81	243K to 393K (-30oC to +120oC)
 REINER	G.P. Staby1 LEP 2	253K to 393K (-20oC to +120oC)
	E.P. Ceplattyn KG 10	243K to 523K (-30oC to +250oC)
 SHELL	G.P. Calithia EP Fett T 2	248K to 403K (-25oC to +130oC)
	E.P. Cardium Fluid C	243K to 333K (-30oC to +60oC)
 TEXACO	G.P. Multifak EP 2	243K to 403K (-30oC to +130oC)
	E.P. Crater 2 X Fluid	253K to 393K (-20oC to +120oC)

G. P. = GENERAL PURPOSE

E. P. = EXTREME PRESSURE I.E. SLEWING RING GEARS ETC.

SECTION

7

A.R.M. (U.K.) Ltd.

'Touchdown - 6 Car' Operation & Maintenance Manual

GENERAL HYDRAULIC MAINTENANCE

	<u>PAGE</u>
General circuit maintenance	45
Oil.....	45
Pipes	46
Pipe maintenance	46
General maintenance and operation.....	47
Pump Chatter.....	48
Air in the system.....	48
Bleeding air from cylinders.....	49
In the event of a Breakdown	50
Pumps and motors	50
Cylinder removal	50
Cylinder servicing	51
Re-installation	51
Valves etc.....	52
Summary.....	52
Fault finding chart.....	53

GENERAL CIRCUIT MAINTENANCE

An hydraulic circuit is one of the most trouble free systems of power transmission yet evolved. With correct maintenance and periodic inspection it will give many years of trouble free service.

It should be remembered that in order to obtain good overall efficiency the main components, pumps, cylinders and control valves are manufactured to very close tolerances, the clearances between moving parts in many cases being in the order of 0.005mm (0.0002 in). It therefore follows that absolute cleanliness must be maintained within the system.

It is essential that users of hydraulic systems should read and remember the following general instructions.

OIL

The care of the oil in the system is of utmost importance since the oil lubricates in addition to actually transmitting the power. Failure to heed the points set out below will usually lead to a stoppage.

- 1) Do not let the oil in the system overheat. Overheating not only breaks down the oil and causes damage to seals but lowers the viscosity thus reducing efficiency. If a cooler is fitted in the circuit, ensure that the supply to the cooler is switched on whilst the system is in operation.
- 2) Check the reservoir oil level indicator at regular intervals. In the event of a rapid lowering of the oil level check all seals in the equipment and all pipe joints for leakage. Keep the oil level as near to 'full' as possible and under no circumstances run the system with the oil level below three quarters full. If this is done air may be introduced into the system with disastrous results.
- 3) Unless otherwise recommended a complete oil change must be carried out every 12 months. Use the correct grade of oil when refilling.
- 4) Do not top up the reservoir with a different brand of oil to that already in use. Although the new oil may be quite suitable on its own, the inhibitors it contains may not mix with those in the oil in use.
- 5) Fill reservoir with the recommended hydraulic fluid. For normal applications use mineral oil: Shell Tellus 37 or equivalent.
- 6) Store all new oil in sealed containers away from extreme temperatures. Open containers will quickly collect fluff and dust, and oil so fouled will rapidly choke

SECTION 7

filters.

- 7) Do not use dirty oil in the system. Filters will choke rapidly and oil will not circulate satisfactorily.
- 8) Do not run the system with the air cleaner off the reservoir.
- 9) Do not attempt to clean out reservoir using cotton waste or any similar material. Lint material will inevitably cause sticking valves.
- 10) When operating indoors in steamy or humid atmospheres, pipe the breather through partitions or walls to a clean dry place. This will help considerably to keep moisture from the oil.

PIPES

In the event of an hydraulic pipe needing replacement, the following guidelines should be followed:-

- 1) Ensure that only genuine manufacturers replacement parts are used.
- 2) Eliminate sharp bends wherever possible. Smooth, even bends prevent turbulence and increase efficiency.
- 3) Keep pipe runs as short as possible. Long pipe runs increase frictional losses and reduce efficiency.
- 4) Do not kink hydraulic hose. A good general rule is to ensure that the radius of the bend is not less than five times the outside diameter of the hose.
- 5) Only new piping should be used for installation or replacements. This will avoid dirt being carried into the oil and causing damage to valves and cylinder bores. When the pipe has been welded it must be pickled before installation to remove scale.
- 6) Do not use pipe with defective threads or leakage will result.
- 7) Do not allow any sealing compound to enter the pipes. This will mix with the oil and cause contamination.
- 8) Tighten all pipe connections firmly. A loose connection causes leakage.
- 9) If a leak does occur, stop the system by turning off the motor and tighten up the joint. Do not undo the pipe while the system is running. Avoid accidents by cleaning up all oil spilt on the floor.

PIPE MAINTENANCE

Maintenance of the pipe system is extremely simple. The following points should be noted.

- 1) Make regular inspections of all pipe work to ensure that no leaks are present
- 2) Examine pipes for signs of external damage. A severe blow may cause a dent, weakening the pipe and restricting the oil flow.
- 3) Examine flexible hose for signs of damage and deterioration. After prolonged use, especially in hot atmospheres, leaks may occur around the ends of the pipes.

GENERAL MAINTENANCE AND OPERATION

- 1) Examine all external oil seals periodically. Remove and replace defective seals as necessary.
- 2) It is advisable to run the system with pressure gauge needle taps closed to prevent undue wear on the instrument. Approximately one quarter turn of the needle in an anti-clockwise direction will permit pressure to register on the gauge. Adjustment of pump pressure is carried out by alteration of the setting on the relief valve. Instructions for this are given on the appropriate data sheet. Subsidiary circuit pressure may sometimes involve reducing valves.
- 3) Check the mounting bolts of all units at regular intervals. All units must be secure, especially those in high pressure systems.
- 4) Do not operate units at pressures greater than those recommended. Hydraulic units must only be used with the recommended oil at a pressure not greater than that stated on the rating plate.
- 5) In the event of a breakdown attempt to trace the fault starting from the pump and working outwards. Do not tear the system to pieces indiscriminately.
- 6) Do not use cotton waste or similar material to clean any part of a system. Once cotton waste has been introduced into a system numerous troubles will occur.
- 7) Handle all hydraulic equipment with care. Many parts are precision manufactured to very fine limits and rough handling will cause damage.
- 8) Protect the piston rods of cylinders whilst maintenance is in progress. Damage to piston rods will mean damage to wiper and internal seals, causing leakage and loss of efficiency.

SECTION 7

PUMP CHATTER

Noisy operation of hydraulic pumps may be caused by any condition that limits the flow of oil to the suction side of the pump. In this event, the pump is operating only partially filled with oil, the remaining working space consisting of a vacuum. The result is uneven distribution of oil in the pump, giving rise to noisy operation.

The cause is often a restricted suction due to a partial blockage on the suction side of the pump. Other possible causes are the use of oil of too high a viscosity or the ingress of air into the suction side of the pump. In the latter case noise is again due to unequal distribution of fluid, the pump being only partially filled with oil. If air enters the system it will be observed that the oil becomes hot. Erratic operation of the final drive will result. This may be cured by bleeding the system, after taking action to prevent air entering the system (See section 'Air in the System').

AIR IN THE SYSTEM

Smooth action within a hydraulic system is ensured to a large degree by the incompressibility of the oil. This incompressibility is severely impaired when air enters the system and irregular action of valves and cylinders, accompanied by chattering and vibration, will result.

Air in the system may also seriously affect the performance and durability of the oil. Even though the general temperature of the oil does not show an excessive rise, local oxidation may take place. This usually occurs as air enters the pump. Here it is compressed from normal atmospheric pressure to the outlet pressure of the pump, and particularly when present as large bubbles, undergoes a rapid increase in temperature. Oil surrounding each air bubble may be subjected to a temperature peak of up to 1100°C and becomes badly scorched and oxidised, even though the size of the bubbles are such that a rise in temperature of the total oil content is not obvious. Oxidisation of this type is cumulative and will eventually effect the whole system.

To rid the system of air, proceed as follows:-

1. Trace the point at which the air is entering. It is no use ridding the system of air before this is done. On new or recently dismantled systems this precaution is usually unnecessary since air will have entered at the point where units were removed. When air is entering a system inadvertently, it is usually through small holes in suction lines or packing glands. However, there are other ways by which air may enter as follows:
 - a) Too low an oil level in the reservoir. This permits air to be drawn into the pump suction.
 - b) Low oil level in the reservoir permitting returning oil to cascade into reservoir. Air may mix in the falling oil and be drawn back into the system, particularly if a rapid flow is used with a fairly small tank.
 - c) Loose joint connections on pump suction pipe.
 - d) By pouring oil into the tank too quickly when topping up. Slow pouring will prevent an oil/air mixture.

In general, a good air-tight system, correct oil level and submerged return lines will prevent the ingress of air. Bleeding need then only take place when a complete oil change is carried out or when units are installed, replaced or partially dismantled in situ as part of general maintenance.

BLEEDING AIR FROM CYLINDERS

When the cylinder is reconnected in circuit, it should be bled of air before the piston rod is coupled to the mechanism it operated.

1. Slacken right off the pressure setting of the relief or other valve which controls the thrust of the cylinder.
2. With pipe connections tight, reciprocate cylinder three or four times by operating its reversing valve to separate air and oil. The relief valve may need a slight increase in pressure setting to move the piston rod.
3. Slacken front pipe connection, actuate cylinder until bubbling ceases and only oil is emitted, then with piston rod fully extended, re-tighten pipe connection.
4. Slacken rear pipe connection and proceed as in (3) above, re-tighten pipe connection when piston rod is fully retracted.
5. Couple up piston rod and set relief valve at circuit working pressure.

IN THE EVENT OF A BREAKDOWN

1. Check the circuit systematically, starting from the pump. Do not tear out the system haphazardly.

DO NOT ATTEMPT TO REMOVE UNITS WITH THE PUMP RUNNING.

2. Having traced the faulty unit and removed it from the circuit, ensure that the oil supply is OFF. To remove a unit proceed as follows:

PUMPS AND MOTORS

1. Cut off oil supply, disconnect all pipe connections and catch fluid in a clean receptacle. Clean fluid can be used again in the system.
2. Disconnect the drive, take out all mounting bolts and remove unit from circuit.
3. Double pump units must be uncoupled before dismantling. To do this proceed as follows:-
 - a) Remove the casing drain connection in the coupling house.
 - b) Rotate the pump shaft until the coupling grubscrews are accessible through the aperture. Undo one grubscrew only.
 - c) Take out the bolts and set screws attaching the pumps to the coupling house.
 - d) Separate the pumps and remove the coupling from the pump shaft by taking out the remaining grubscrew. To rejoin units the procedure must be reversed.

CYLINDER REMOVAL

1. Cut off the oil supply, disconnect the pipe connections and catch the escaping fluid in a clean receptacle.
2. Uncouple the piston rod, remove the mounting bolts or clevis pins and withdraw the cylinder from the circuit.
3. Drain the oil through the ports.

CYLINDER SERVICING

1. Examine all seal rings for hardness or cracks and renew as necessary.
2. Blow out all ports and drilling with compressed air.
3. Check all threaded parts for stripped threads.
4. Soak all metal parts in trichloroethylene or similar solvent.
5. All traces of solvent must be removed prior to re-assembly, preferably using clean, dry compressed air.

Special points to observe when servicing individual units are given in the individual unit instructions.

RE-INSTALLATION

Careful re-installation of all units removed for servicing is of utmost importance. All parts must be clean and free from foreign matter.

Other points to watch are:

1. Bolt all units firmly in position before testing system. This applies especially to hydraulic cylinders.
2. When first starting the system after maintenance, or removal of parts, slacken off relief valve setting until just enough pressure remains in the circuit to work the actuators. It will be found advisable to leave the actuators uncoupled if this is at all possible. By doing this, and gradually increasing the circuit pressure, you will be saved the inconvenience of leaks at high pressure.

SECTION 7

VALVES ETC.

1. Ensure that the pump drive is switched off and, where possible, turn off oil supply.
2. Disconnect all pipes and catch escaping oil in a clean receptacle.
3. Plug open pipes to prevent ingress of dirt. Do not use fluffy material.
4. Take out mounting bolts and remove unit from circuit.

Reverse this procedure when replacing valve.

SUMMARY

It must be emphasised that this section is only a general guide to the maintenance of hydraulic systems. There are obviously many common sense precautions that have not been covered and occasionally faults may arise as the result of a series of events that could not be foreseen.

By observing the points covered you may rest assured that your equipment will function satisfactorily under normal circumstances for many years.

Should any difficulties arise, please do not hesitate to contact the manufacturer A.R.M. (U.K.) LTD.

FAULT FINDING CHART

<u>FAULT</u>	<u>CAUSE</u>	<u>REMEDY</u>
Pump not delivering oil.	Wrong direction of rotation of pump.	Reverse pump direction at once or damage may result.
	Insufficient oil in reservoir.	Add oil until gauge registers full.
	Suction line or oil filter blocked.	Remove and clean filter.
	Air leak in suction line.	Replace or tighten as necessary.
	Oil viscosity too high.	Change oil to that recommended.
Noisy pump.	Failure of pump.	Replace damaged pump.
	Air in system.	Bleed as recommended.
	Choked pump inlet or filter.	Clean as necessary.
	Air leak in pump suction line.	Test by pouring oil on joints and listening for change in noise. Tighten connections.
	Reservoir intake blocked.	Reservoir must have open breather.
	Air leak around pump shaft seal.	Pour oil over pump seal and listen for change in noise. Change seal.
	Chattering relief valve.	Air being drawn into system.
Pump running too fast.		Check speed.
Oil too high viscosity.		Change to correct oil.
Oil level is low.		Top up with oil.
System fails to develop pressure.	System relief valve jammed open.	Dismantle and examine.

SECTION

8

A.R.M. (U.K.) Ltd.

'Touchdown - 6 Car' Operation & Maintenance Manual

SERVICE BULLETINS

Service Bulletins sent out by the manufacturer should be inserted in this manual after this page

CARNYTOWN.COM

STATE OF FLORIDA
DEPT. OF AGRICULTURE
INSPECTION DIVISION



ATTN: SANDY

(USA) INC.

1506 Fernwood Rd. • Wintersville, Ohio 43952
Telephone: (614) 264-6599 • Fax: (614) 266-2953

MARCH 5, 1998

THIS DOCUMENT IS TO VERIFY THAT THE FOLLOWING AMUSEMENT RIDE
MEETS OR EXCEEDS ALL A.S.T.M. STANDARDS.

RIDE SERIAL #: MTD1/10/10/97USA

VIN # SA9ST5224UE030001

RIDE TYPE: TOUCHDOWN

MANUFACTURE: A.R.M. (UK) LTD.

REGARDS;

PATRICK T. REDMOND
PRESIDENT

