

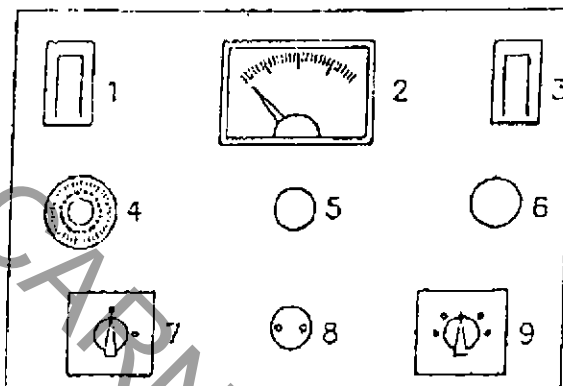

Falgás U.S.A. Inc.

Kiddie Rides



TRAIN
CONTROL BOX
SWITCHES

- 1 - SWITCH 110V. AC INPUT
- 2 - DC METER
- 3 - DC SWITCH OUTPUT
- 4 - TIMER
- 5 - LIGHT POWER
- 6 - START SWITCH
- 7 - MAIN SWITCH
- 8 - ON/OFF ADDITIONAL START HAND SWITCH /
- 9 - SPEED SELECTOR

INSTRUCTIONS TO OPERATE

- 1 - SELECT OPERATION TIME WITH SWITCH #4 (TIMER)
- 2 - MAIN START (ON) SWITCH, SWITCH #7
- 3 - PUSH START BUTTON, BUTTON #6
- 4 - ON/OFF ADDITIONAL START HAND SWITCH, SWITCH #8
- 5 - SPEED SELECTOR - SWITCH #9

1.- OVERALL DIMENSIONS

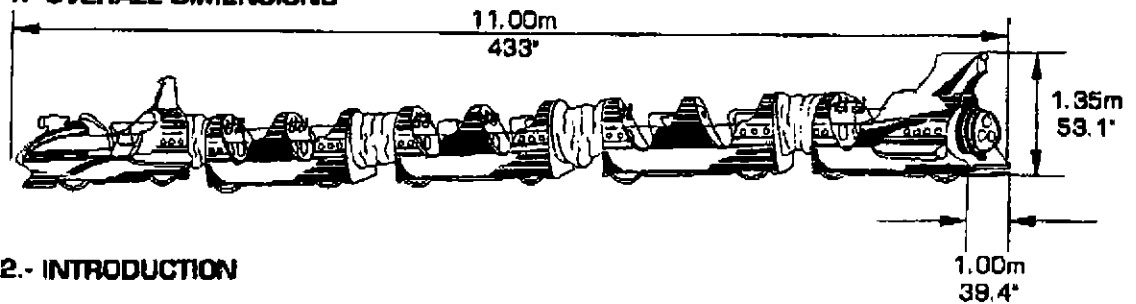

2.- INTRODUCTION

We thank you to choosing our product. We are convinced that you will be satisfied with it and that it will satisfy all your needs.

This manual contains some interesting information about the train installation, its future maintenance or its repairing.

3.- ATTENTION! POINTS TO TAKE INTO ACCOUNT

- Machine is designed to be directed by a person through a control board. This person must be able to see the whole railway.
- In case it rains we advise you not to use the train.
- Control board must be plugged into an earthconnected socket.
- The control board should be placed within a booth to protect it from the effects of the environment (rain, wind, dust, ...)
- The whole track of the rain will be protect through a fence, so that nobody can cross the rails while the train is running.
- When the flexible power supply wire of this machine is damaged, it has to be substituted by the special flexible power supply cable RV-K 3G2.5.

4.- MACHINE CHARACTERISTICS

- Power: 3500W (when train runs with maximum speed)
- Power when train is resting position: 360W
- Timer adjustable between 2 and 12 minutes
- Machine's speed can be changed
- Railway power: 24Vcc
- Electromechanical train's control
- Maximum speed: at 3000 r.p.m. and 24V is 8Kmph

5.- INSTALLATION

You must take next points into account to make a correct installation:

Land must be completely level with an unevenness of 0%

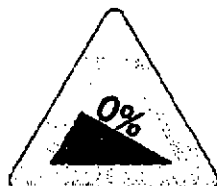

1

Mount railway only pointing screws

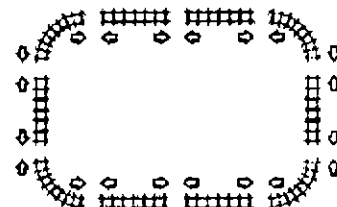

2

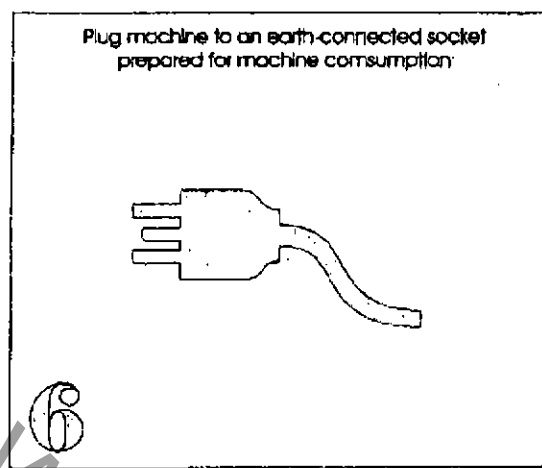
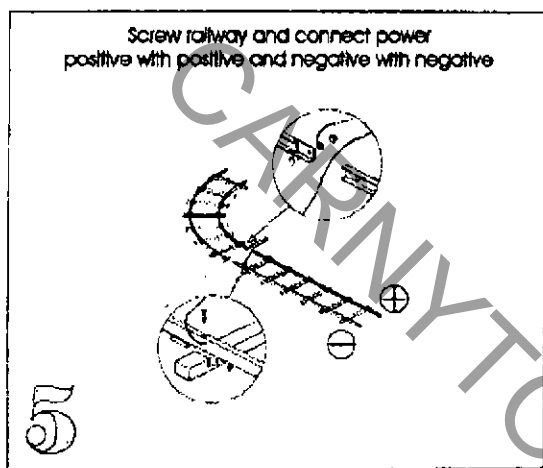
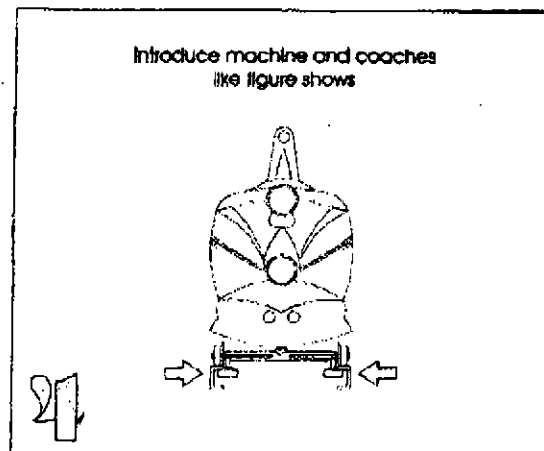
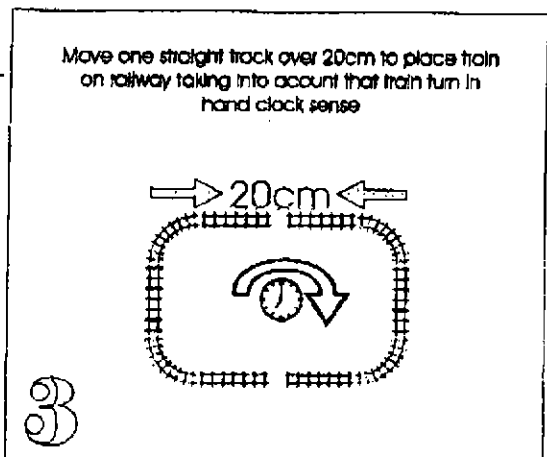

6.- START UP

First you must connect control board to an earthconnected socket prepared for machine's consumption. Before starting up the train you must check the tracks connection, they must respect polarity. Train always must turn in hourly sense (changes polarity sense when train stops).

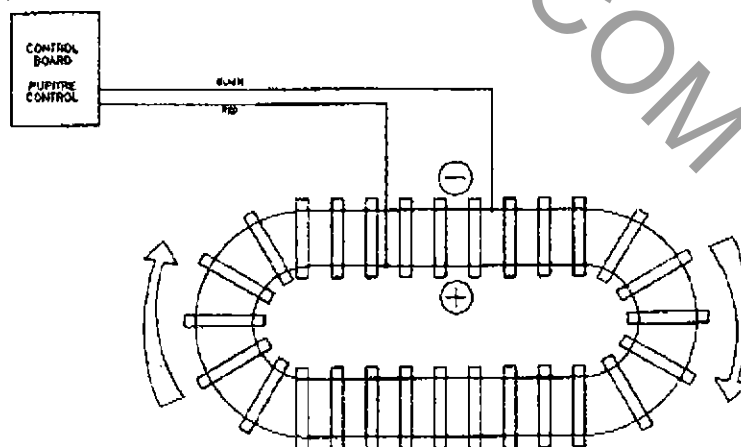

RAILWAY POLARITY AND TURNING SENSE WHEN TRAIN IS RUNNING
(When train is stopped polarity have the opposite sense)

CONTROL BOARD SOUND SCHEME

ESQUEMA SONIDO PUPITRE

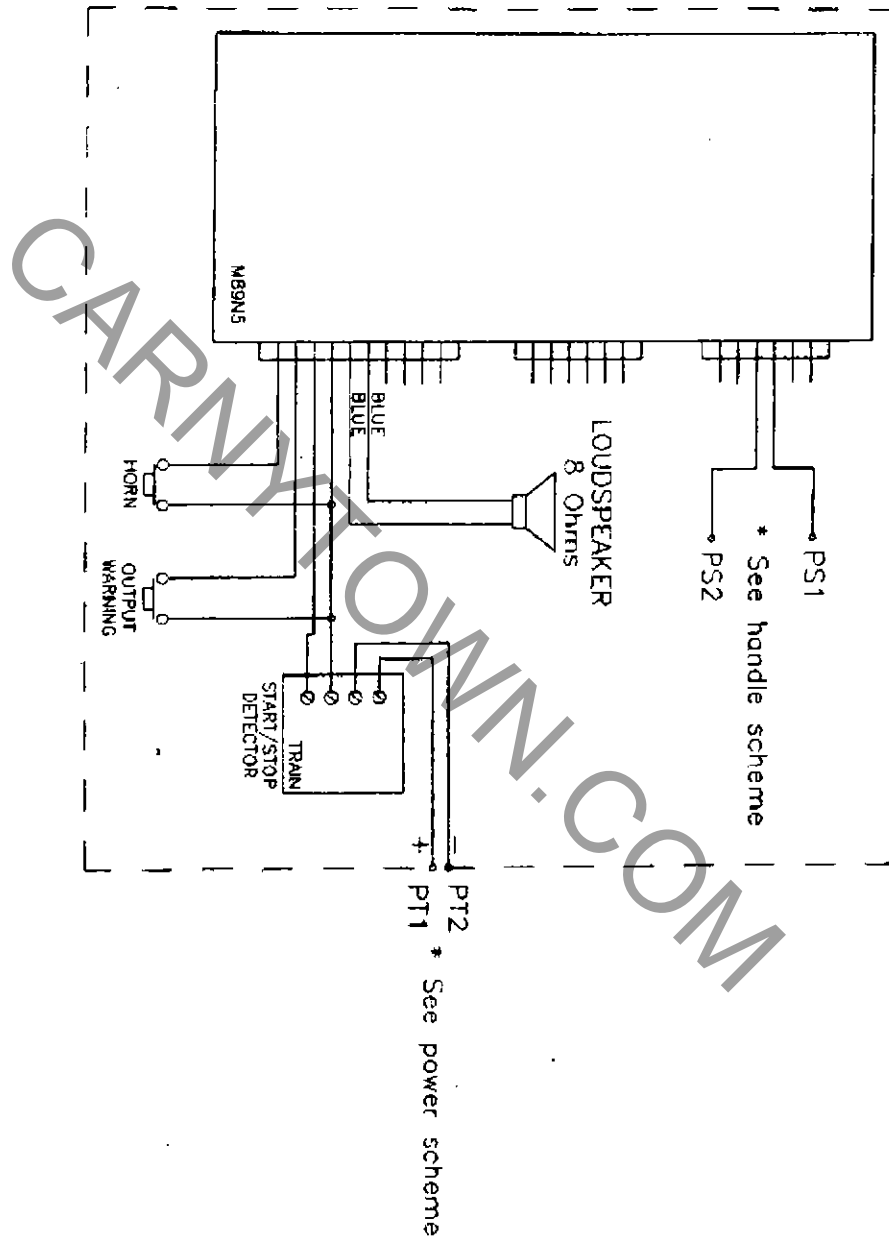

LOCOMOTIVE INSTALLATION

INSTALACIÓN DE LA MÁQUINA

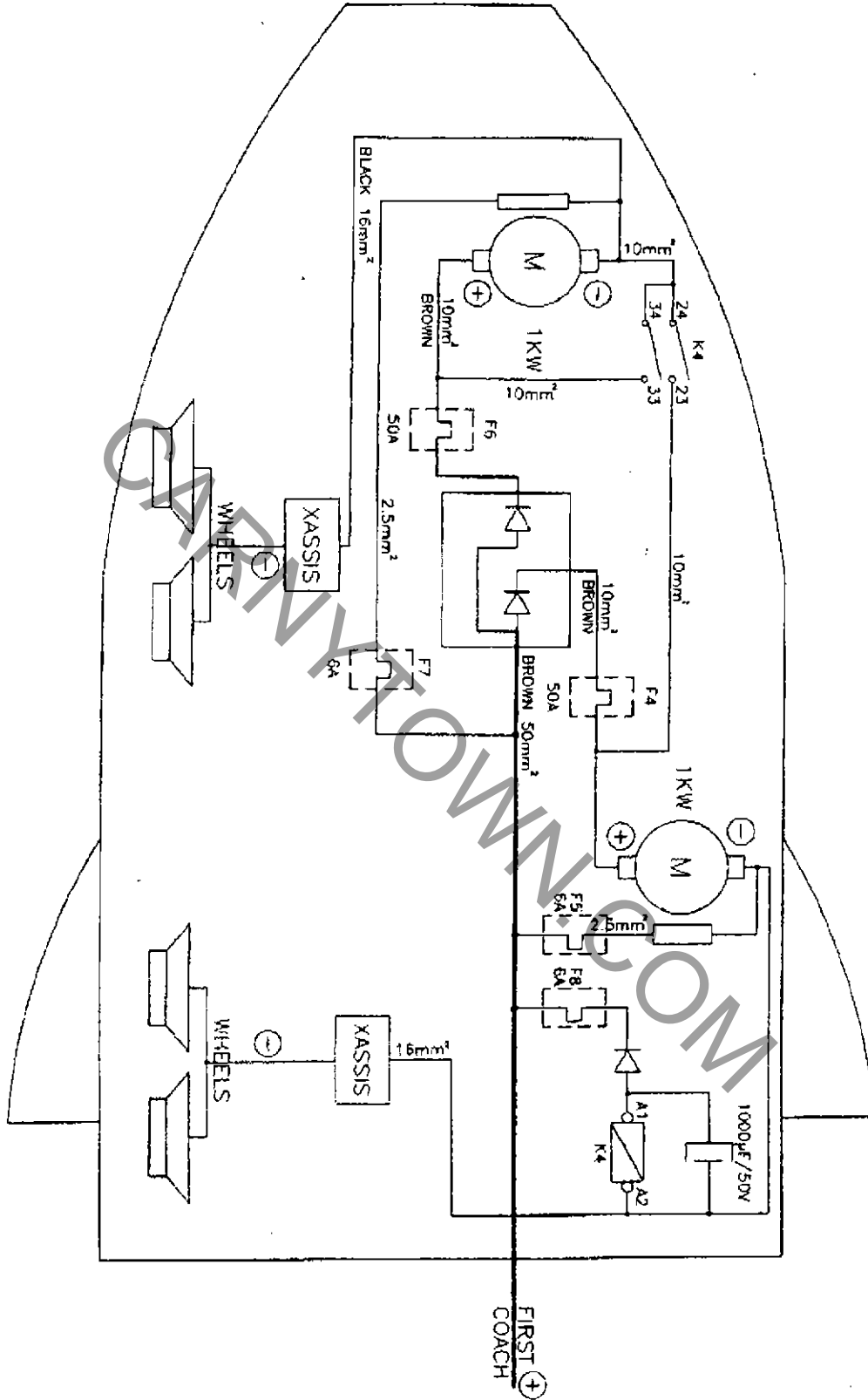

FALGAS

LIGHTS INSTALLATION

INSTALACIÓN DE LAS LUCES

⊗ 6V 5W

LOCOMOTIVE
MAQUINA

WAGONES
COACHES

COLA
ENDING COACH

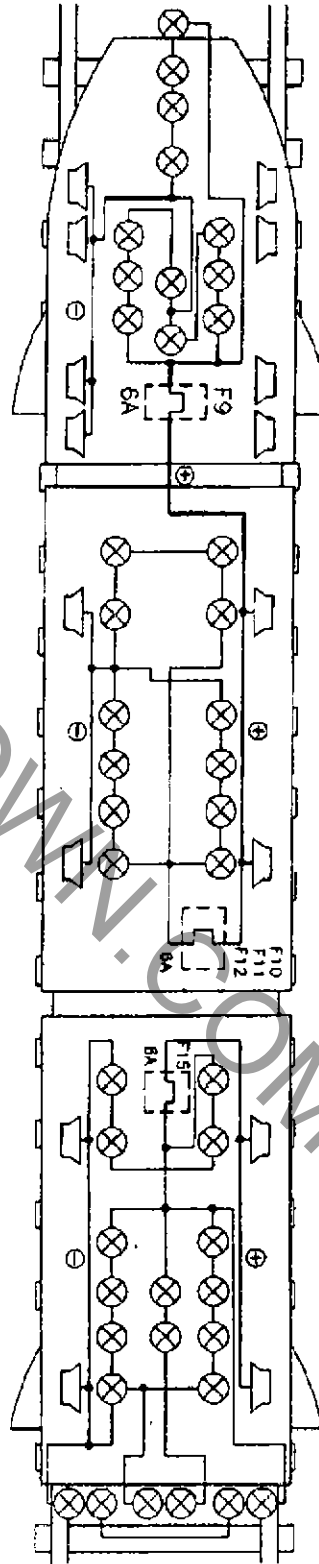

SOUND INSTALLATION

INSTALACIÓN DEL SONIDO

MAQUINA
LOCOMOTIVE

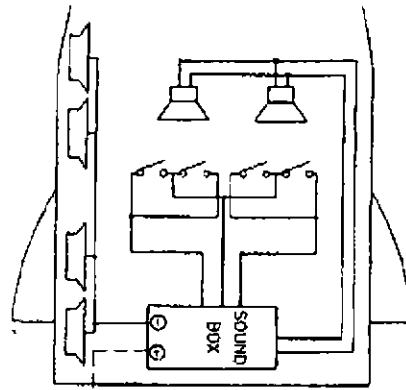

First coach only

WAGONES
COACHES

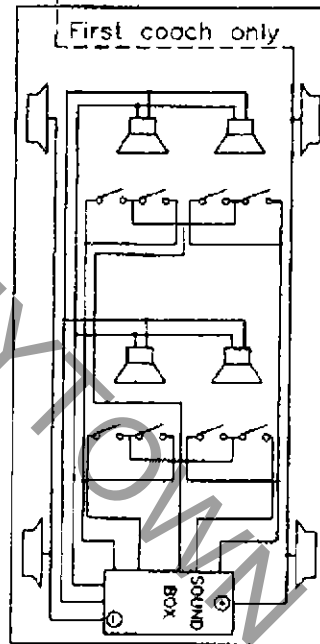

COLA
END COACH

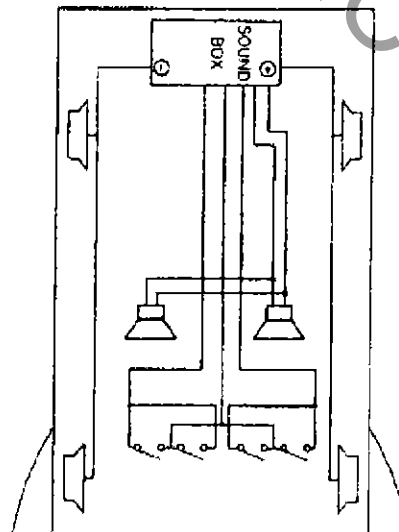

FALGAS

CONEXIONADO SIRENA

SIREN CONNECTIONS

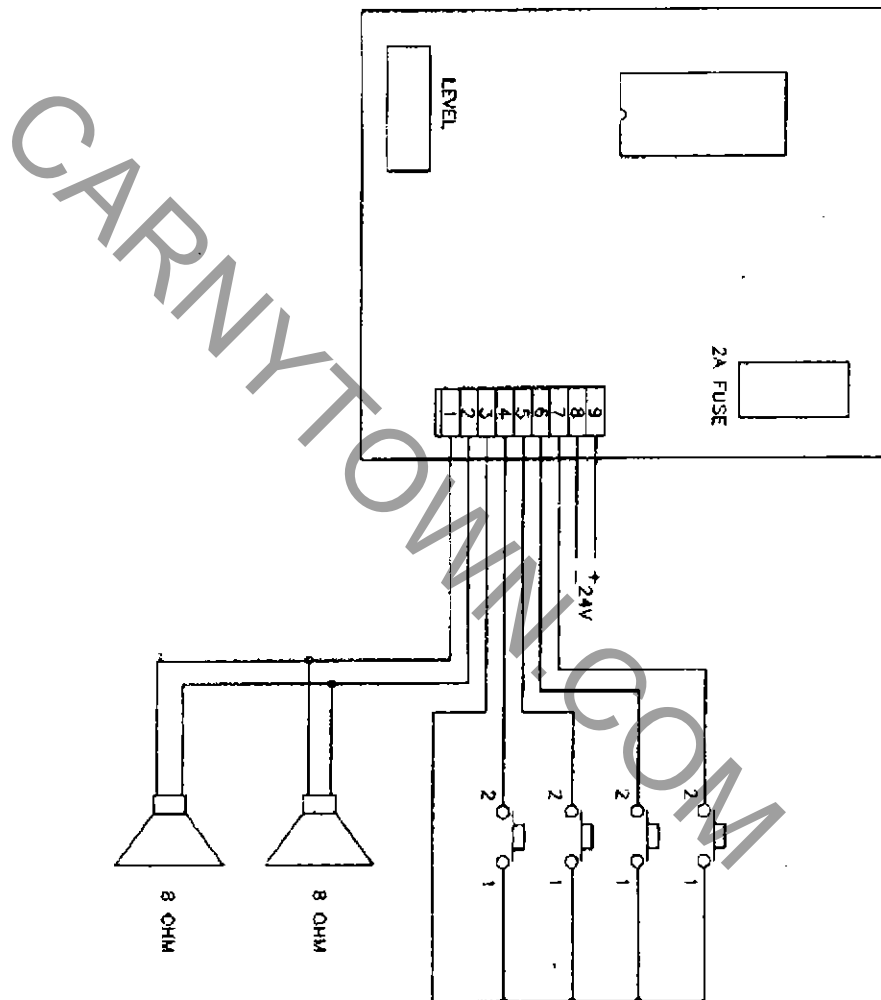

GUIDE OF DIAGNOSE AND REPARATION

CIRCUMSTANCE	SYMPTOM	CAUSE	REPAIR
When control board is connected the train starts running with out giving ride	When START is pushed trains runs but F3 stops	Wrong connection of wires between command board and railway	Change direction of polarity of connections in railway
Doesn't stop	Ride time finished and train doesn't stop	Timer faulty	A technician must replace by one as same characteristics
	Train doesn't stop when STOP is pushed	Push button faulty or connections disconnected	A technician must replace or check installation
	The train stops as same as stops for timer or through the STOP push button	K4 connections wrong or contactor faulty	A technician must check installation
Train doesn't start	Nothing occurs when START is pushed	START push button faulty or disconnected	Check button and connections
		Timer faulty	Replace
		Belt motor broken	Replace
	K1 doesn't work when START is pushed	Chain of transmission broken	Replace
		K2 contactor faulty or wrong connection	A technician must check or replace
		T3 timer faulty	A technician must replace
		K1 and K2 start when START is pushed but train doesn't run	Magnetothermic F2 not activated
Wrong connection railway-command board	A technician must check		
Upon pressing START works wrong	it works stumbles with noise	Teeth of the plions are wasted	Replace
		Shaft of reshiment waged	Replace
There are no lights	There are no lights when train stops	K3 lights counter faulty	A technician must replace
		T2 timer faulty	A technician must replace
	Lights in one the coaches doesn't light up	Thermic disconnected	Connect lights thermic
		There is a short-circuited in the installation	Check connections and bulbs
Thermics of the train are disconnected	Thermic F4 or F6 are disconnected	Too much consumption of the engine	A technician must check engines and mechanism
	Thermic F11, F12, F15, F9 or F10 are disconnected	Too much consumption in the lights or short circuit in any lempholder	A technician must check installation and lights
	F2 magnetothermic desactivates	Diodes faulty or railway shortcircuited	A technician must check
	F3 magnetothermic desactivates	Railway shortcircuited or wrong connection through command board and railway	A technician must check

There is no sound in control board	TIMER-SOUND led in the music box lights up	Potentiometer set to minimum	Set potentiometer to + position
		Speaker short-circuited or disconnected	Replace or connect correctly
		Micro processed board faulty	Consult technical service
	TIMER-SOUND led doesn't light up	Check F13 fuse	Replace by other with same value
There is no sound in train's commands	Train's command faulty	Micro processed board faulty	Consult technical service
		Commands disconnected or faulty	Connect or replace
		Sound board faulty or fuse burned out	Replace by fuse with the same value or consult technical service
		Speakers faulty or disconnected	Replace or connect

CARNYTOWN.COM

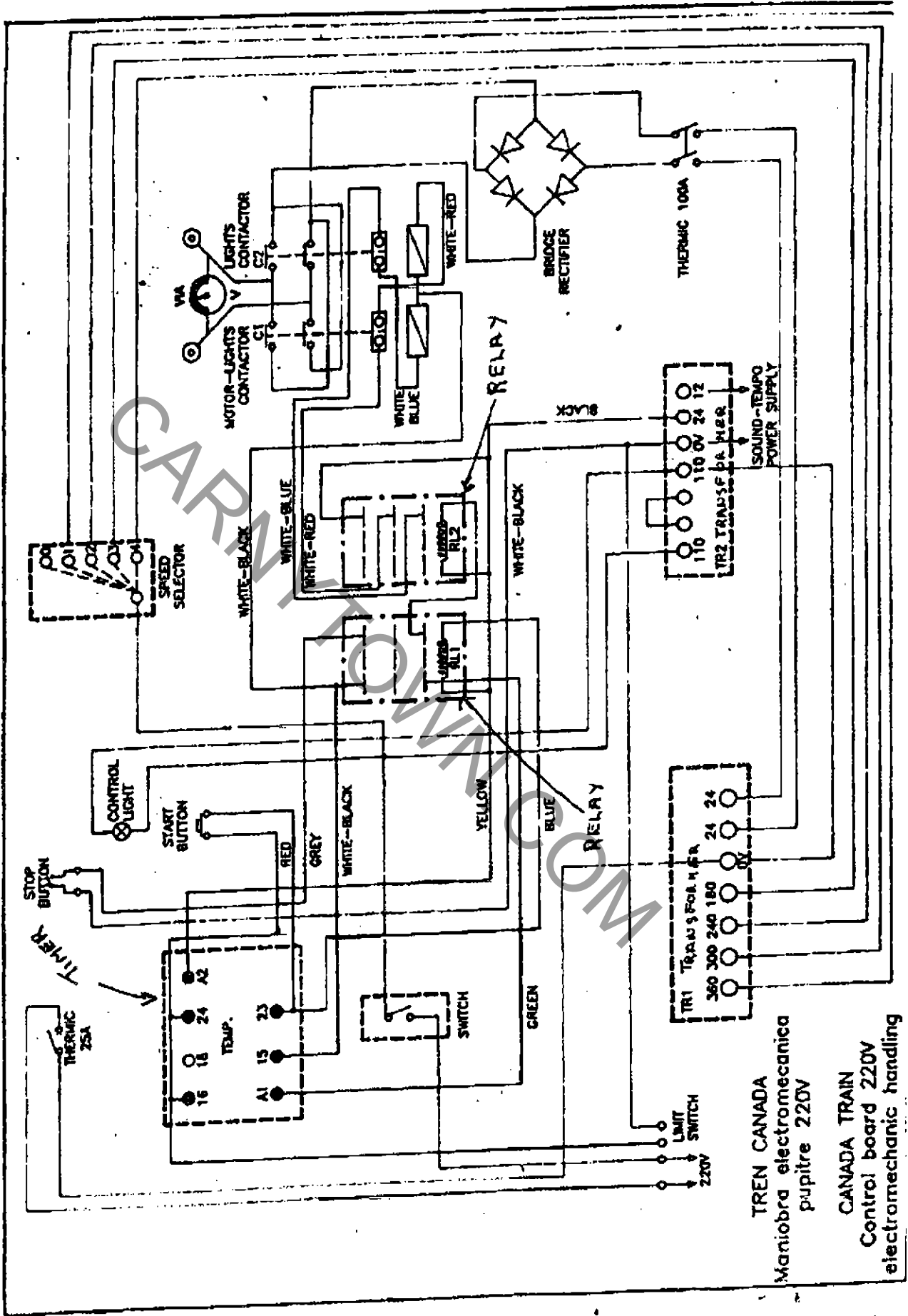

TREN CANADA
 Mariobra electromecanica
 pupitre 220V

CANADA TRAIN
 Control board 220V
 electromecanica handling

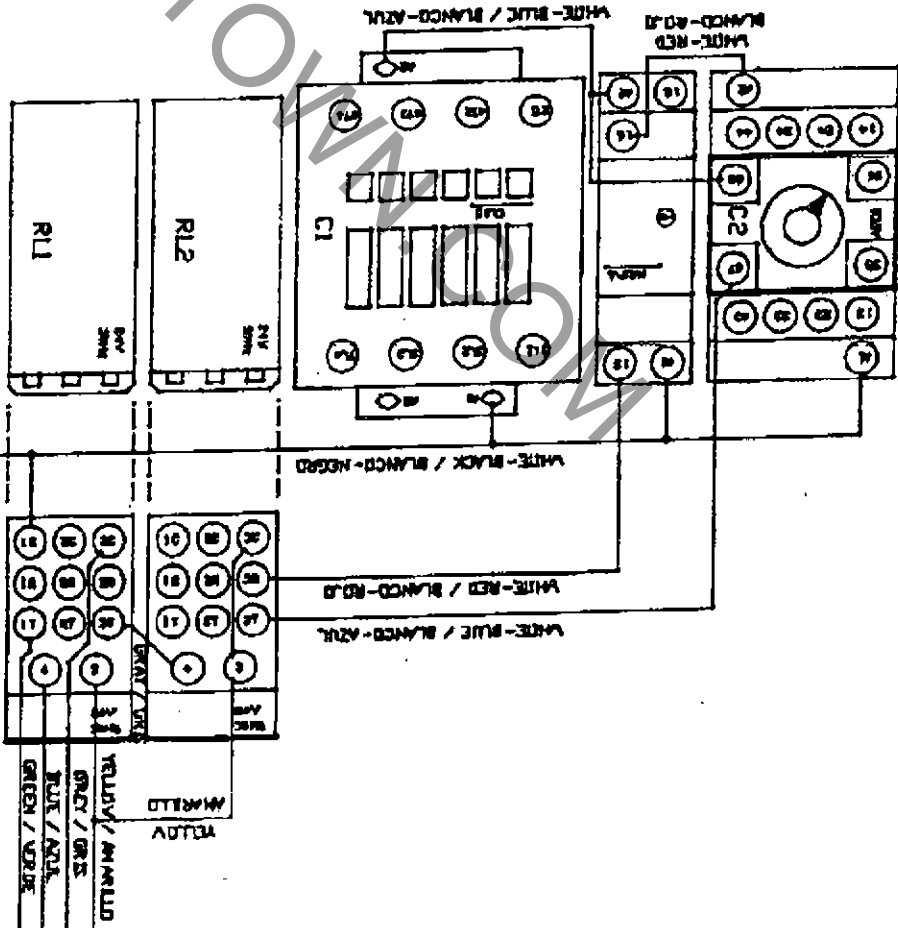
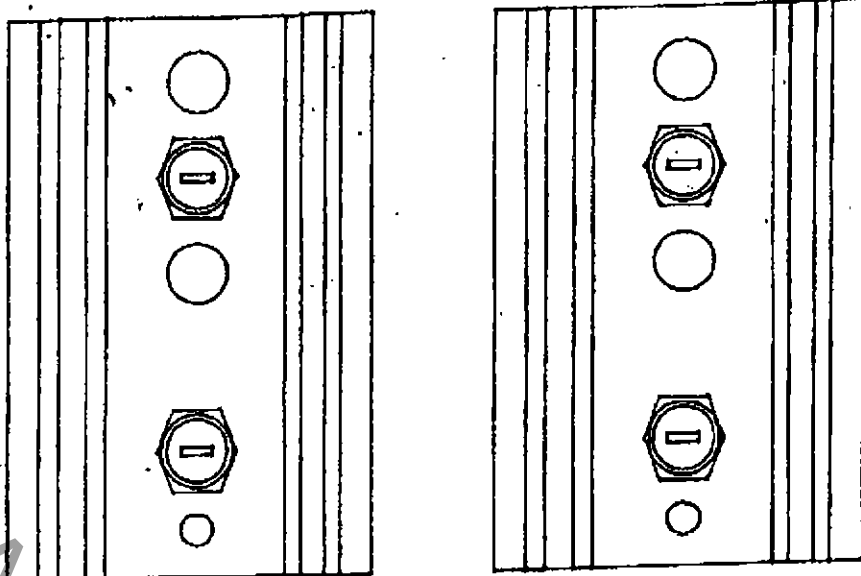

Fecha: 1-4-94	1-4-94	Dominio: 11-11-94	CANADA	INDUSTRIAS FALGAS S.A.
Modelo: 11-11-94				
Material: 11-11-94			CONTROL CONNECTION CONEXION CONTROL	No. partes: 11-11-94
WIRE: 11-11-94				
CABLE: 11-11-94				2/2

12-24 WC

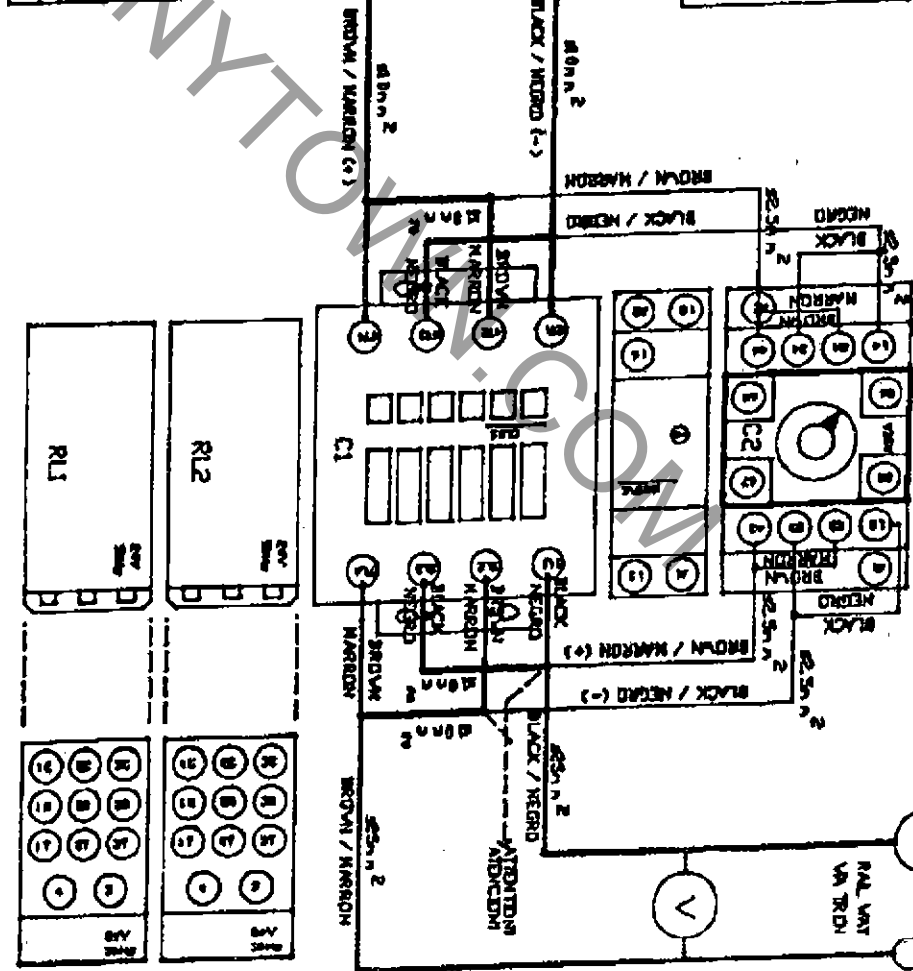
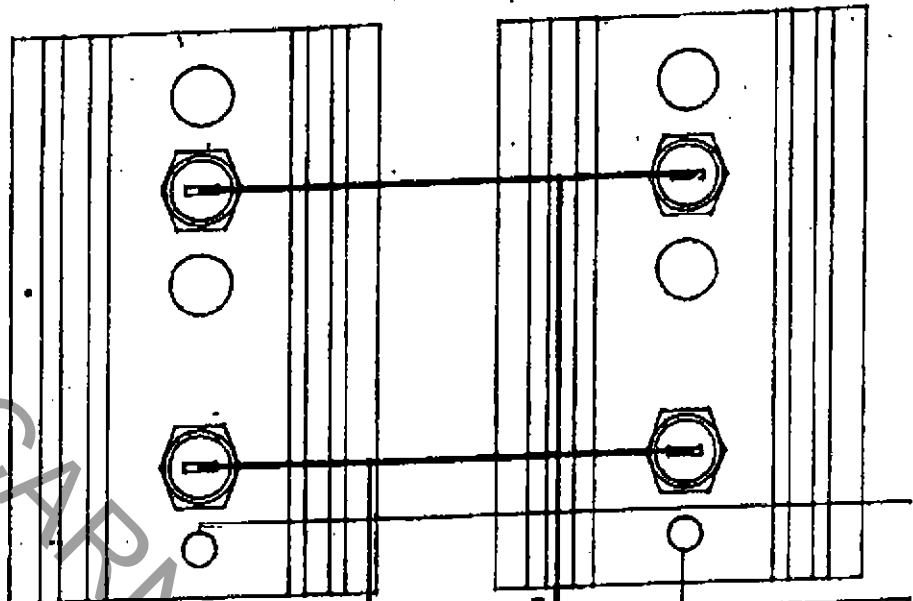

Project No. 1-6-94	Forma Invocada: PAV 8
Drawn by: [Blank]	<p align="center">CANADA</p> <p align="center">POWER CONNECTION CONEXION POTENCIA</p>
Checked by: [Blank]	
Scale: [Blank]	<p align="center">INDUSTRIAS FALGAS S.A</p> <p align="center">No. Plano: PAV 8-10-10</p>
Sheet: [Blank]	1/2

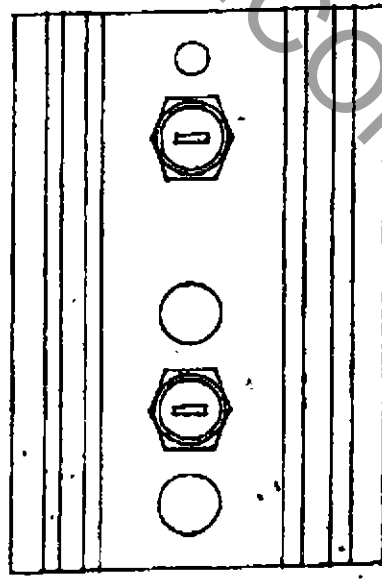
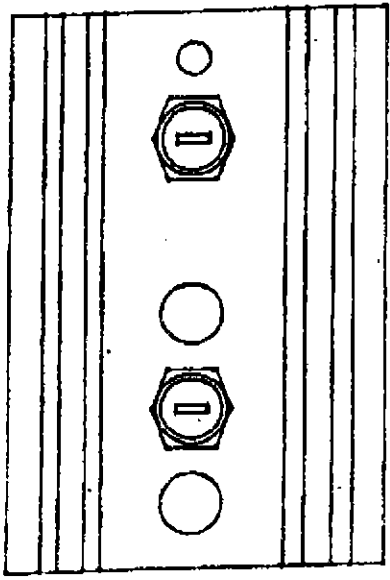
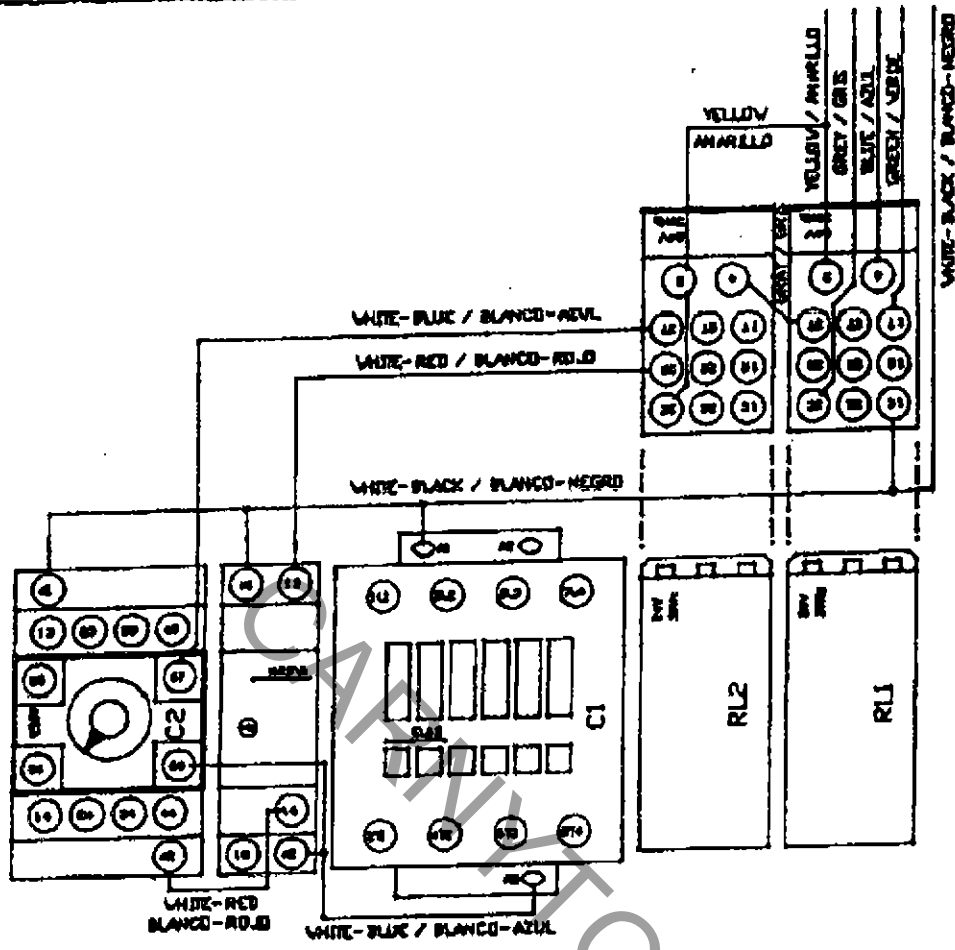

Fecha: 26/04/97 Elaborado por: Revisado por: Controlado por: Verificado por: VRS: 26-73 m 2 CABLE:	1-0-94 Diagrama: 1000-0	INDUSTRIAS FALGÁS S.A. N.º plano: Plano número	3/9
CANADA CONTROL CONNECTION CONEXION CONTROL			
		Control Chart	